

RoHS This products can apply to the SESO Doc NO. QA-3-04-005 of Environmental&Material Management Rules

A VIEW

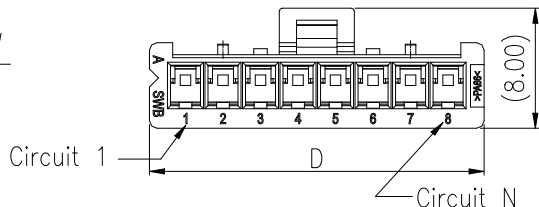
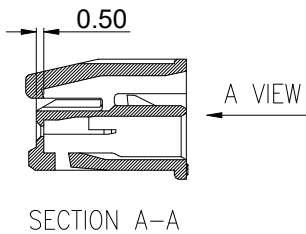
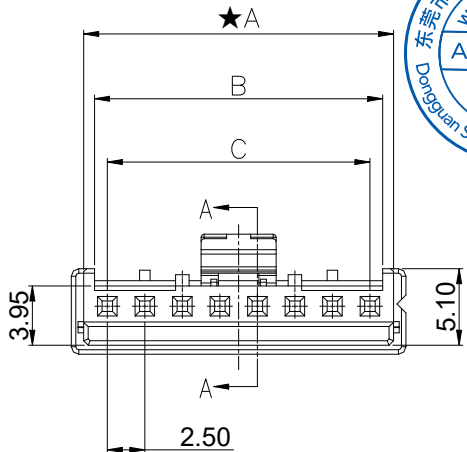
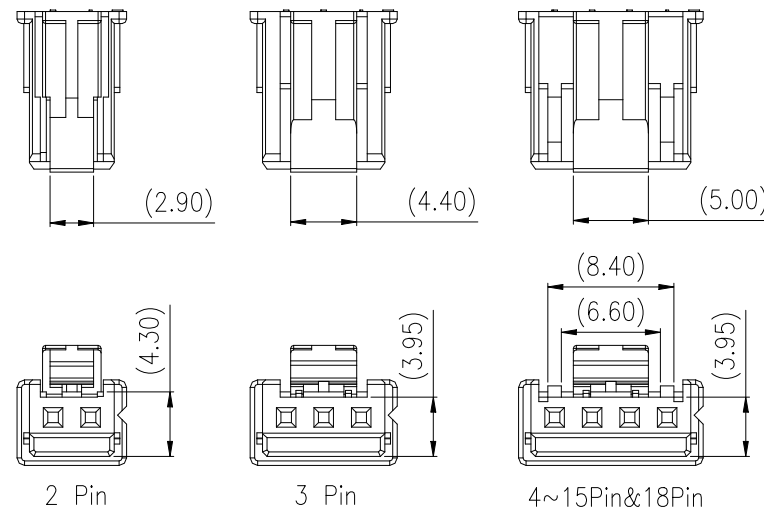
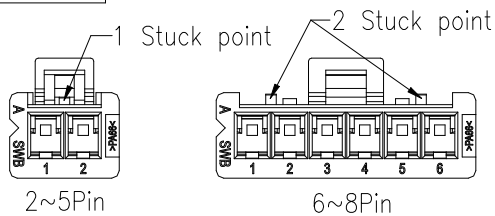
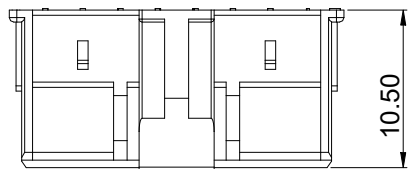

2513 H -XX -NOHF NC
① ② ③ ④ ⑤

- ① Series No.:2513
- ② Connector Type:H-Housing
- ③ Row No.-Pin No:XX-Single Row 02~15Pin&18Pin
- ④ Plastic Material:NO-PA66 (UL94-V0)
HF-Halogen Free
- ⑤ Color:NC- Natural

- Specifications
- Voltage Rating:50V AC/DC
 - Withstanding Voltage:1000V AC/Minute
 - Temperature Range:-40°C~+125°C
 - Insulation Resistance:100MΩ Min./500V DC/Minute
 - Mates With SESO Terminal:2513TX-XXX
 - Mates With SESO TPA:C2513-XX
 - Mates With SESO Wafer:2508WX-XX
 - Product Specification:PS-2513-02
 - Packaging Drawing:PK-2513H-XX-NOHFNC
 - Symbols for SPC Dimensions:★

Poles	Dimensions/mm				Poles	Dimensions/mm			
	A	B	C	D		A	B	C	D
2	5.65	4.20	2.50	7.30	10	25.65	24.20	22.50	27.30
3	8.15	5.80	5.00	9.80	11	28.15	26.70	25.00	29.80
4	10.65	9.60	7.50	12.30	12	30.65	29.20	27.50	32.30
5	13.15	11.70	10.00	14.80	13	33.15	31.70	30.00	34.80
6	15.65	14.20	12.50	17.30	14	35.65	34.20	32.50	37.30
7	18.15	16.70	15.00	19.80	15	38.15	36.70	35.00	39.80
8	20.65	19.20	17.50	22.30	18	45.65	44.20	42.50	47.30
9	23.15	21.70	20.00	24.80					

20231030	A1	/	Update surface	Guo	Larry Yang
20200305	A	/	Initial release	Cai Zhao	John Yang
DATE	REV	ECN NO.	DESCRIPTION	MODIFY	APPROVAL

GENERAL TOLERANCE
.X ±0.35
.XX ±0.25
.XXX±0.15
X.' ±2'

PROJECT
APPROVAL: Jack Zhang
CHECK: Larry Yang
DRAWN: Guo
DATE: 2020/03/05

SMS 东莞市思索技术股份有限公司
Dongguan SESO Technology Co.,Ltd.

PART NO. 2513H-XX-NOHFNC				
TITLE 2.50 WTB CONN. Housing				
UNIT	SCALE	SHEET	REV	NUMBER
mm	1:1	1/1	A1	CD

RoHS

This products can apply to the SESO Doc NO. QA-3-04-005 of Environmental&Material Management Rules

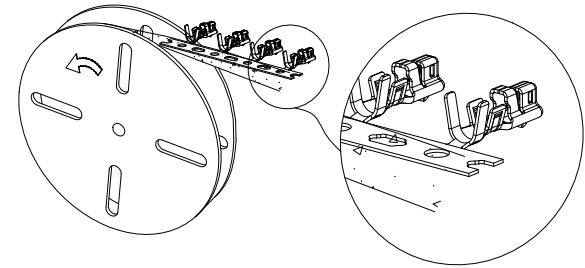
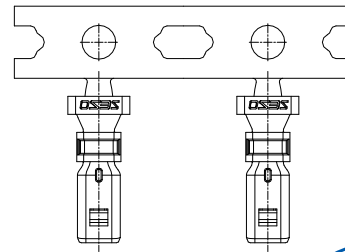
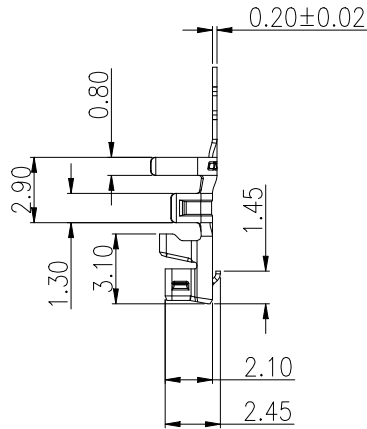
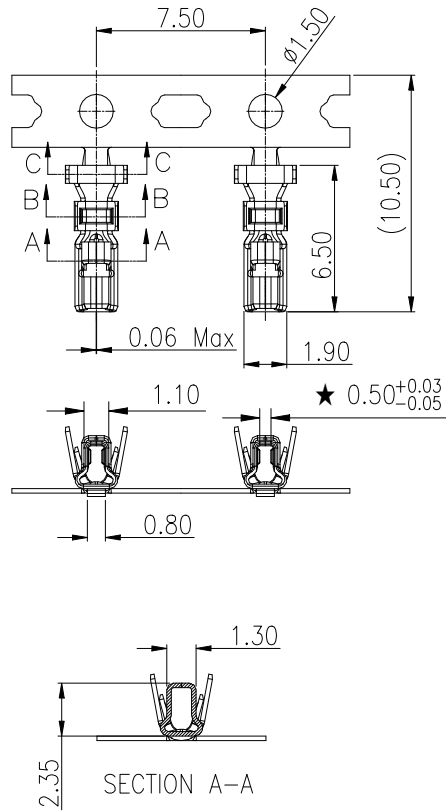

Specifications:

- Current Rating: 2.5A AC/DC(0.22mm² Wire)
3A AC/DC(0.35mm²~0.5mm² Wire)
- Temperature Range: -40°C~+125°C
- Contact Resistance: ≤10mΩ(Initial)
≤20mΩ(After Testing)
- Mates With SESO Housing:2513H-XX
- Packaging Drawing:PK-2513TX-XXX
- Product Specification:PS-2513-02
- Symbols for SPC Dimensions:★

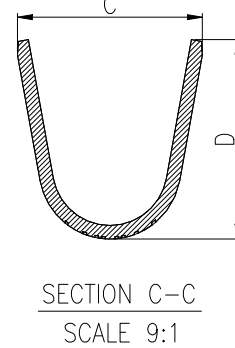
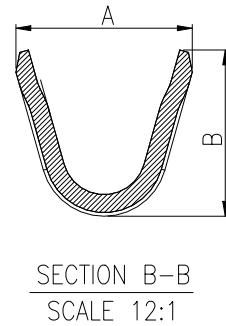

2513 I X - H Y2 B
① ②③ ④ ⑤ ⑥

- ① Series No.:2513
- ② Category:T-Terminal
- ③ Shape:L-Low Feet ; H-High Feet
- ④ Material:H-High conductivity copper
- ⑤ Plating Code:
Y2-40~120u"(1~3um) TIN
- ⑥ Plating Process:
B-Stamping After Plating

Table:

2513TH-HY2B	AWG#22~20 (0.35~0.5mm ²)	ø1.60mm Max	1.96	1.84	2.75	2.95
2513TL-HY2B	AWG#24 (0.22mm ²)		1.90	1.50	2.75	2.95
Part NO.	Wire Range	Insulation O.D.	Dim.A	Dim.B	Dim.C	Dim.D

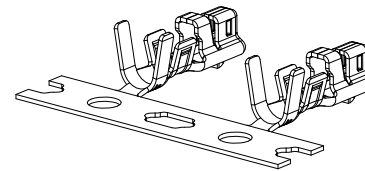

20231030	A4	/	Update surface	Guo	Larry Yang
20221229	A3	/	Update surface	Wangcheng	Larry Yang
20221102	A2	/	Modifying the terminal Structure	Wangcheng	Larry Yang
DATE	REV	ECN NO.	DESCRIPTION	MODIFY	APPROVAL

GENERAL TOLERANCE	
.X	±0.35
.XX	±0.25
.XXX	±0.15
.X.' ±2'	
PROJECT	
①	②

SMS 东莞市思索技术股份有限公司
Dongguan SESO Technology Co.,Ltd.

APPROVAL	CHECK	DRAWN	DATE
Jack Zhang	Larry Yang	Guo	2020/03/05

PART NO. 2513TX-HY2B				
TITLE 2.50 WT B CONN. Terminal				
UNIT	SCALE	SHEET	REV	NUMBER
mm	1:1	1/1	A4	CD

RoHS

This products can apply to the SESO Doc NO. QA-3-04-005 of Environmental&Material Management Rules

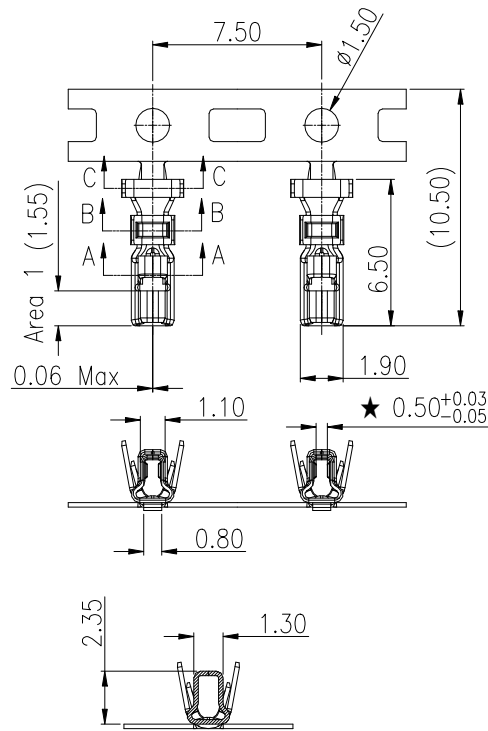
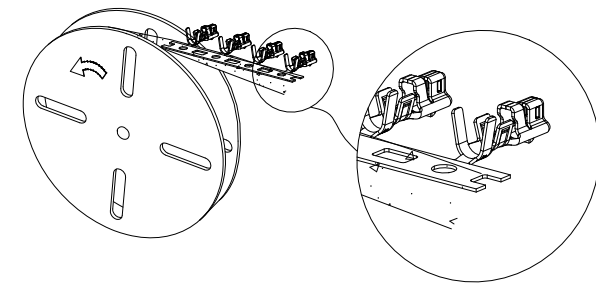

SECTION A-A

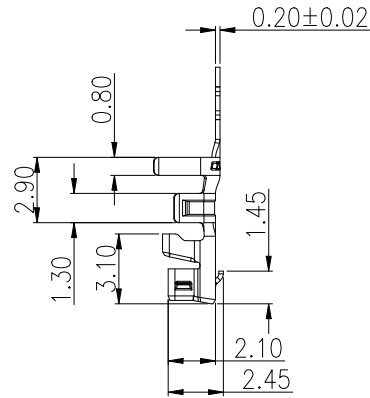

SECTION B-B
SCALE 12:1

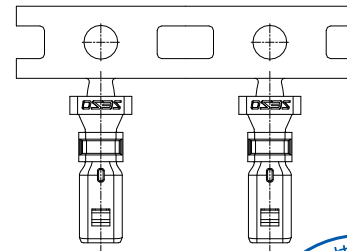

SECTION C-C
SCALE 9:1



Specifications:

- Current Rating: 2A AC/DC(0.13mm² Wire)
2.5A AC/DC(0.22mm² Wire)
3A AC/DC(0.35mm²~0.5mm² Wire)
- Temperature Range:
-40°C~+105°C(Phosphor Bronze)
- Contact Resistance: <10mΩ (Initial)
<20mΩ (After Testing)
- Mates With SESO Housing:2513H-XX
- Packaging Drawing:PK-2513TX-XXX
- Product Specification:PS-2513-01
- Symbols for SPC Dimensions:★

2513 I X - P XX X
① ②③ ④ ⑤ ⑥

- ① Series No.:2513
- ② Category:T-Terminal
- ③ Shape:L-Low Feet ; H-High Feet
- ④ Material:P-Phosphor Bronze;
- ⑤ Plating Code:

SN1-Underplate Ni 40~120u”(1~3um) ;
Top Plating Sn 80~200u”(2~5um)
GN01-Underplate Ni 40~120u”(1~3um) ;
Area 1 Plating Au 1u”(0.025um)Min
V8-50u”(1.25um)min Ni,
8u”(0.2um)min AU

- ⑥ Plating Process: Blank-Stamping Before Plating

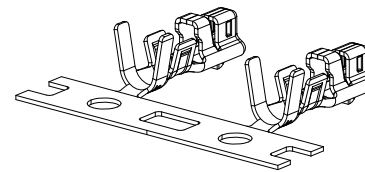

Table:

2513TH-PXXX	AWG#22~20 (0.35~0.5mm ²)	Ø1.60mm Max	1.96	1.84	2.75	2.95
2513TL-PXXX	AWG#26~22 (0.13~0.35mm ²)		1.90	1.50	2.75	2.95
Part NO.	Wire Range	Insulation O.D.	Dim.A	Dim.B	Dim.C	Dim.D

20231030	B7	/	Update surface		Guo	Larry Yang
20231028	B6	/	Increase overall gold plating		Guo	Larry Yang
20221229	B5	/	Update surface		Wangcheng	Larry Yang
DATE	REV	ECN NO.	DESCRIPTION	MODIFY	APPROVAL	

GENERAL TOLERANCE	
.X	±0.35
.XX	±0.25
.XXX	±0.15
X.' ±2'	
PROJECT	
①	②

SMS 东莞市思索技术股份有限公司
Dongguan SESO Technology Co.,Ltd.

APPROVAL	CHECK	DRAWN	DATE
Jack Zhang	Larry Yang	Guo	2020/03/05

PART NO.				
2513TX-PXXX				
TITLE				
2.50 WT B CONN. Terminal				
UNIT	SCALE	SHEET	REV	NUMBER
mm	1:1	1/1	B7	A-000

RoHS

This products can apply to the SESO Doc NO. QA-3-04-005 of Environmental&Material Management Rules

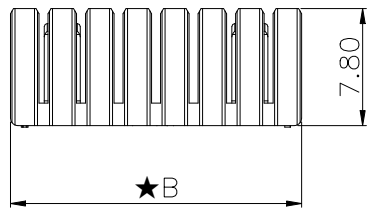
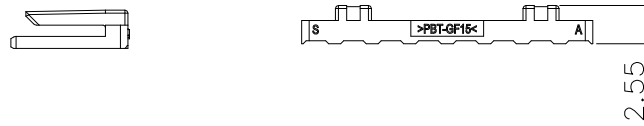
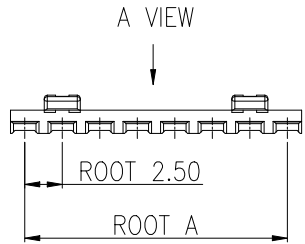
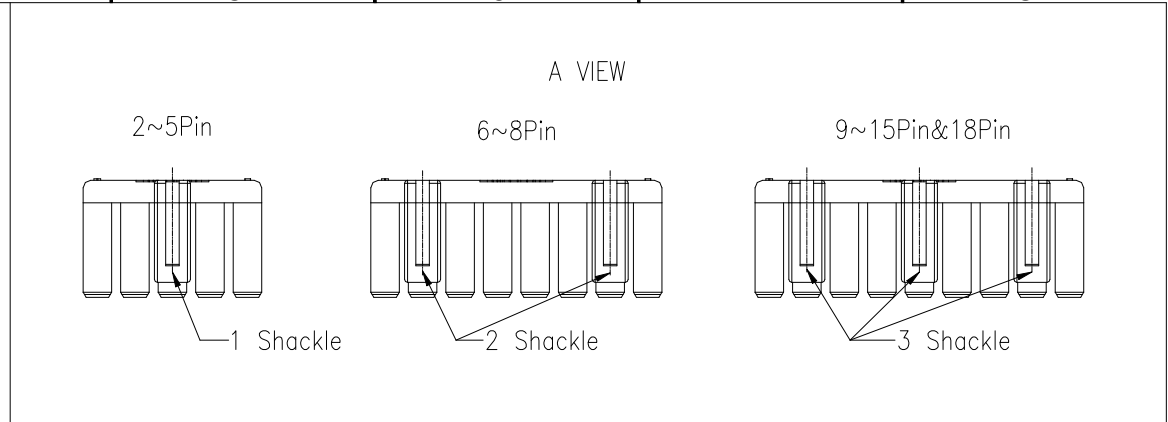
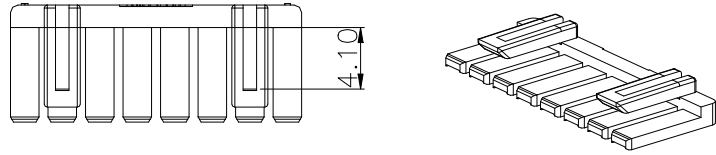

Poles	Dimensions/mm		Poles	Dimensions/mm	
	A	B		A	B
2	2.50	4.40	10	22.50	24.40
3	5.00	6.90	11	25.00	26.90
4	7.50	9.40	12	27.50	29.40
5	10.00	11.90	13	30.00	31.90
6	12.50	14.40	14	32.50	34.40
7	15.00	16.90	15	35.00	36.90
8	17.50	19.40	18	42.50	44.40
9	20.00	21.90			

Specifications

- Voltage Rating:50V AC/DC
- Withstanding Voltage:1000V AC/Minute
- Temperature Range:-40°C~+125°C
- Insulation Resistance:100MΩ Min./500V DC/Minute
- Mates With SESO Housing:2513H-XX
- Packaging Drawing:PK-C2513-XX-PTNC
- Symbols for SPC Dimensions:★



C 2513 XX - PT NC
① ② ③ ④ ⑤

- ① Connector Type:C-TPA
- ② Series No.:2513
- ③ Row No.-Pin No:XX-Single Row 02~15Pin&18Pin
- ④ Plastic Material:PT-PBT-GF(UL94V-0)
- ⑤ Color:NC-Natural

DATE	REV	ECN NO.	DESCRIPTION	MODIFY	APPROVAL
20231030	A1	/	Update surface	Guo	Larry Yang
20200305	A	/	Initial release	Cai Zhao	John Yang

GENERAL TOLERANCE
.X ±0.35
.XX ±0.25
.XXX ±0.15
X.° ±2°

SMS 东莞市思索技术股份有限公司
Dongguan SESO Technology Co.,Ltd.

PROJECT: Jack Zhang, Larry Yang, Guo
DATE: 2020/03/05

PART NO. C2513-XX-PTNC				
TITLE 2.50 WTB CONN. TPA				
UNIT	SCALE	SHEET	REV	NUMBER
mm	1:1	1/1	A1	CD

RoHS

This products can apply to the SESO Doc NO. QA-3-04-005 of Environmental&Material Management Rules



Poles	Dimensions/mm			
	A	B	C	D
2	2.50	5.75	10.00	4.05
3	5.00	8.25	12.50	7.00
4	7.50	10.75	15.00	9.20
5	10.00	13.25	17.50	11.35
6	12.50	15.75	20.00	13.85
7	15.00	18.25	22.50	16.35
8	17.50	20.75	25.00	18.85
9	20.00	23.25	27.50	21.35
10	22.50	25.75	30.00	23.85
11	25.00	28.25	32.50	26.35
12	27.50	30.75	35.00	28.85
13	30.00	33.25	37.50	31.35
14	32.50	35.75	40.00	33.85
15	35.00	38.25	42.50	36.35

Specifications:

- Voltage Rating:50V AC/DC
- Current Rating:3A AC/DC
- Withstanding Voltage:1000V AC/Minute
- Temperature Range:-40°C~+125°C
- Insulation Resistance:100M Ω Min./500V DC/Minute
- Contact Resistance: $\leq 10m\Omega$ (Initial)
 $\leq 20m\Omega$ (After Testing)
- Mates With Housing:2508H-XX, 2513H-XX
- Product Specification:PS-2513-02
- Packaging Drawing:PK-2508WRS-XXE-9TXNR
- Symbols for SPC Dimensions:"★"

2508 W R S-XX E-9T X N R
① ② ③ ④ ⑤ ⑥ ⑦ ⑧ ⑨ ⑩

- ① Series No.:2508
- ② Category:W-Wafer
- ③ Connector Type:R-Right Angle 90°
- ④ Mounting Type:S-SMT
- ⑤ Row No.-Pin No.:
XX-Single Row-02Pin~15Pin
- ⑥ Special No.:E-Stamping Terminal
- ⑦ Plastic Material:9T-PA9T (UL94V-0)
- ⑧ Plating Code:SW1-Matte Tin
Underplate:Ni 40~120u"(1~3um) overall
Top Plating:Sn 80~200u"(2~5um) overall
GW01-Underplate:Ni 40~120u"(1~3um) overall
Contact area Plating Au 1U"(0.025um)Min
Weld area Plating Sn 80~200u"(2~5um)
- ⑨ Color:N-Natural
- ⑩ Packing:R-Reel

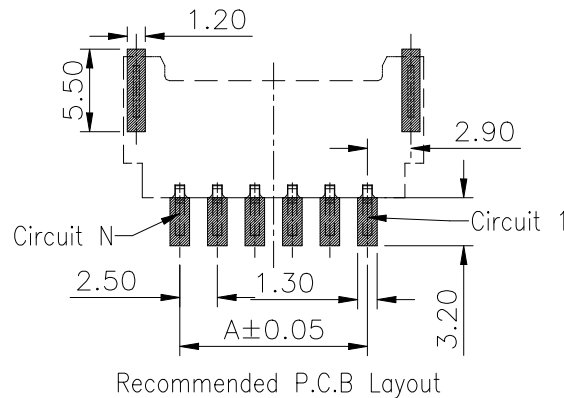
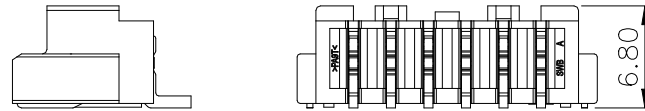
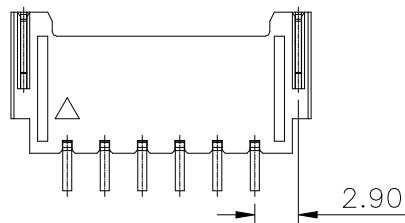
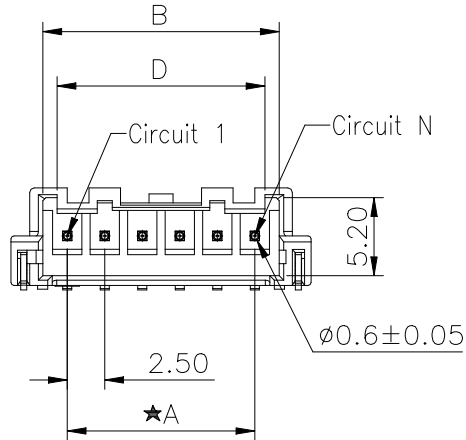
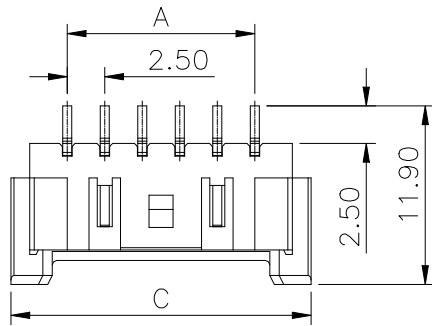
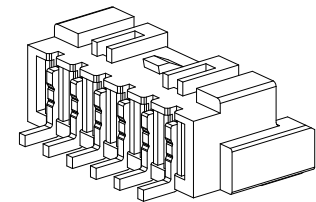

20231031	B1	/	Update borders	Larry Lin	Jack Zhang
20210415	B	EN120210415001	Add the Plating Code GW01	Cai Zhao	John Yang
20210312	A	/	Initial release	Cai Zhao	John Yang
DATE	REV	ECN NO.	DESCRIPTION	MODIFY	APPROVAL

GENERAL TOLERANCE	
.X	± 0.35
.XX	± 0.25
.XXX	± 0.15
X.°	$\pm 2^\circ$
PROJECT	

SMS 东莞市思索技术有限公司
Dongguan SESO Technology Co.,Ltd.

APPROVAL	CHECK	DRAWN	DATE
Jack Zhang	Larry Yang	Larry Lin	2021/03/12

PART NO.				
2508WRS-XXE-9TXNR				
TITLE				
2.50mm WF ASSY right-angle SMT				
UNIT	SCALE	SHEET	REV	NUMBER
mm	1:1	1/2	B1	CD

RoHS

This products can apply to the SESO Doc NO. QA-3-04-005 of Environmental&Material Management Rules

02 Pin

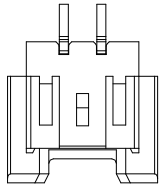

03 Pin

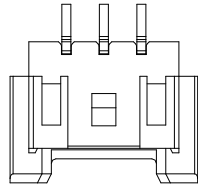

04 Pin

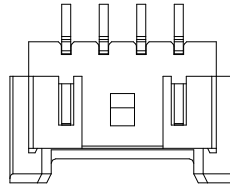

05 Pin

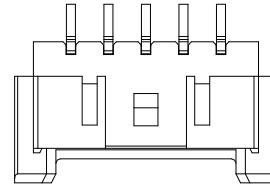

06~15 Pin

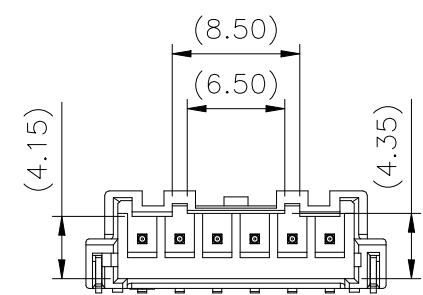
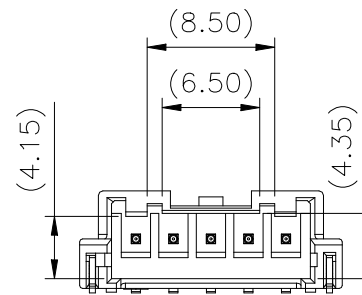
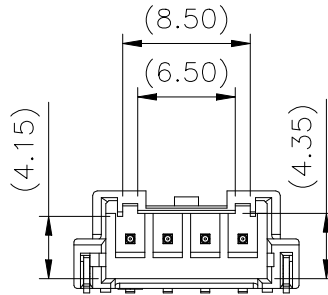
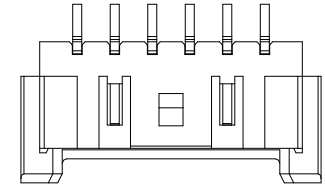

20231031	B1	/	Update borders	Larry Lin	Jack Zhang
20210415	B	EN120210415001	Add the Planting Code GW01	Cai Zhao	John Yang
20210312	A	/	Initial release	Cai Zhao	John Yang
DATE	REV	ECN NO.	DESCRIPTION	MODIFY	APPROVAL

GENERAL TOLERANCE	
.X	±0.35
.XX	±0.25
.XXX	±0.15
X.°	±2°
PROJECT	

东莞市思索技术股份有限公司 Dongguan SESO Technology Co.,Ltd.				APPROVAL	CHECK	DRAWN	DATE
				Jack Zhang	Larry Yang	Larry Lin	2021/03/12

PART NO. 2508WRS-XXE-9TXNX				
TITLE 2.50mm WF ASSY right-angle SMT				
UNIT	SCALE	SHEET	REV	NUMBER
mm	1:1	2/2	B1	CD

RoHS

This products can apply to the SESO Doc NO. QA-3-04-005 of Environmental&Material Management Rules

Poles	Dimensions (mm)		Poles	Dimensions (mm)	
	A	B		A	B
02	2.50	7.50	09	20.00	25.00
03	5.00	10.00	10	22.50	27.50
04	7.50	12.50	11	25.00	30.00
05	10.00	15.00	12	27.50	32.50
06	12.50	17.50	13	30.00	35.00
07	15.00	20.00	14	32.50	37.50
08	17.50	22.50	15	35.00	40.00

Specifications :

- Voltage rating: 250V AC / DC
- Current rating: 3A AC / DC
- Withstanding voltage:1000V AC/minute
- Temperature range: -40°C~+125°C
- Insulation resistance:≥1000MΩ
- Contact resistance: ≤10mΩ
- After environmental testing: ≤20mΩ
- Material(Pin):Brass
- Mates With SESO Housing:2508H、2513H

2508 W R X-XX X-9T SN X X - X
 ①① ①② ①③ ①④ ①⑤ ①⑥ ①⑦ ①⑧ ①⑨ ①⑩ ①⑪

- ① Series No.
- ② Category: W-Wafer
- ③ Connector Type: R-Right angle 90°
- ④ Mouting Type: Blank-DIP
- ⑤ Row No.-Pin No.: XX-02P~15P
- ⑥ Special No.:N-Without post and without kink
 △ Blank-Without post and with kink
- ⑦ Material: 9T-PA9T UL94V-0
- ⑧ Plating Code: SN-Bright Tin Plating
 Underplate:Ni 40~120u"(1~3um) overall
 Top plating:Sn 80~200u"(2~5um) overall
- ⑨ Color : Blank-Natural color;GW-Grey
- ⑩ Packing : Blank-PE bag、T-Tray

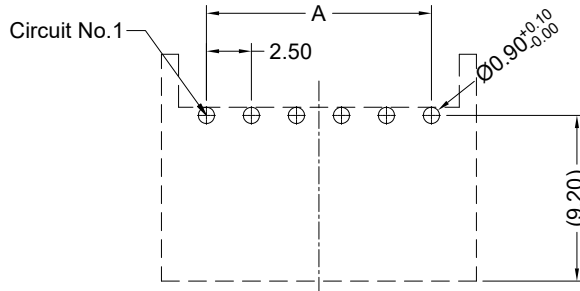
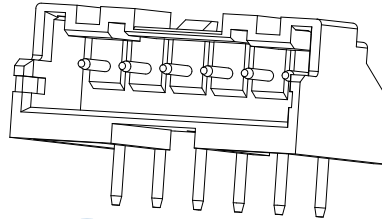
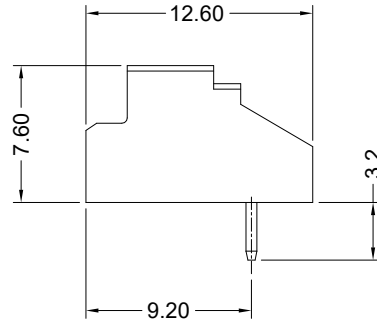
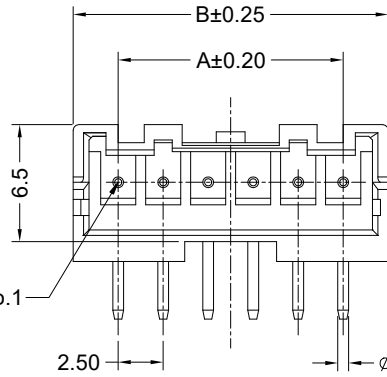
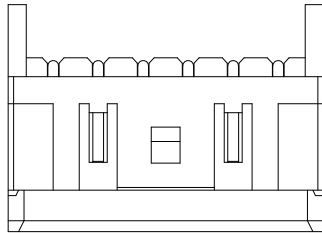

RECOMMENDED P.C.B LAYOUT T=1.60mm (TOLERANCE:±0.05)

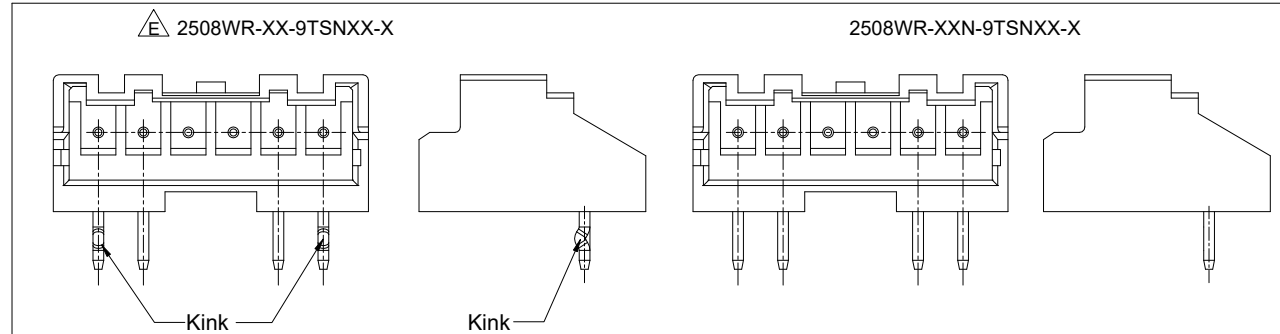

2023/10/31	F1	/	Update borders	Larry Lin	Jack Zhang
2021/05/06	F	EN120210506001	Add new product type	TengMin	John Yang
2021/03/31	E	EN120210331001	Add the specification with kink	Xin Qing	John Yang
DATE	REV	ECN NO.	DESCRIPTION	MODIFY	APPROVAL

GENERAL TOLERANCE	
.X	±0.30
.XX	±0.20
.XXX	±0.10
X.°	±2°
PROJECT	

SMS 东莞市思索技术股份有限公司
 Dongguan SESO Technology Co.,Ltd.

APPROVAL	CHECK	DRAWN	DATE
Jack Zhang	Larry Yang	Larry Lin	2018/04/16

PART NO. 2508WR-XXX-9TSNXX-X				
TITLE 2.50 mm Crimp Style connectors				
UNIT	SCALE	SHEET	REV	NUMBER
mm	1:1	1/2	F1	CD

RoHS

This products can apply to the SESO Doc NO. QA-3-04-005 of Environmental&Material Management Rules

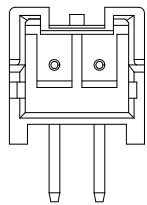

2Pin

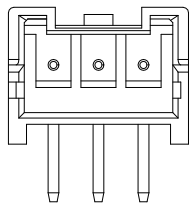

3Pin

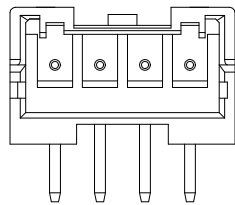

4Pin

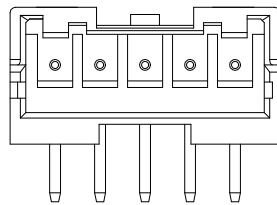

5Pin

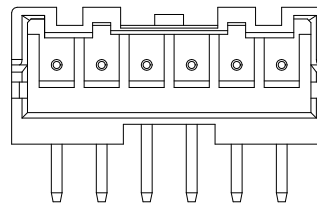

6Pin

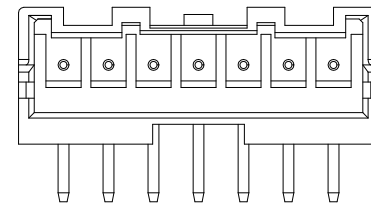

7Pin

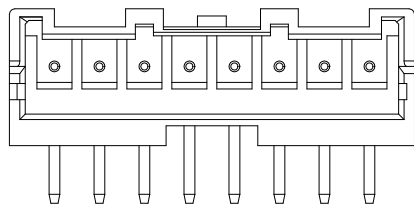

8Pin

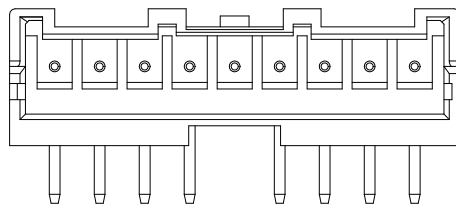

9Pin

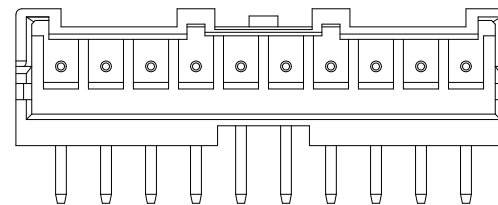

10Pin

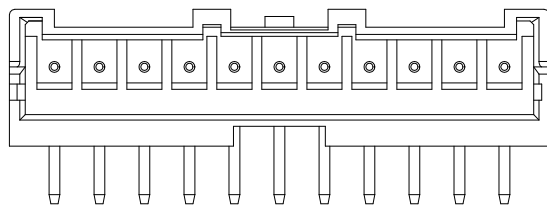

11Pin

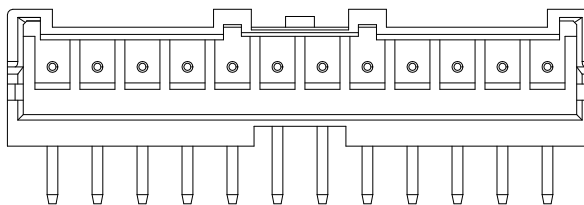

12Pin

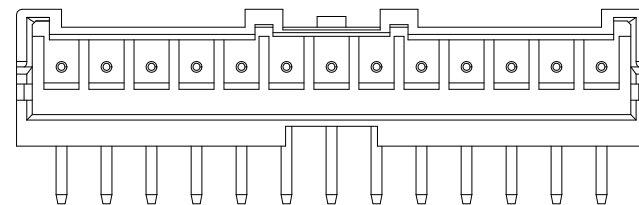

13Pin

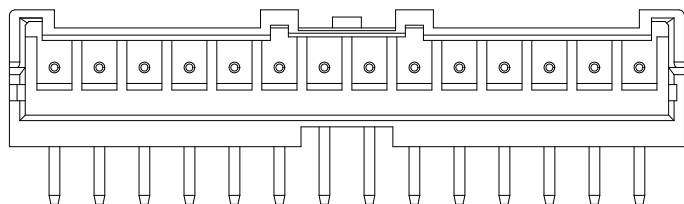

14Pin

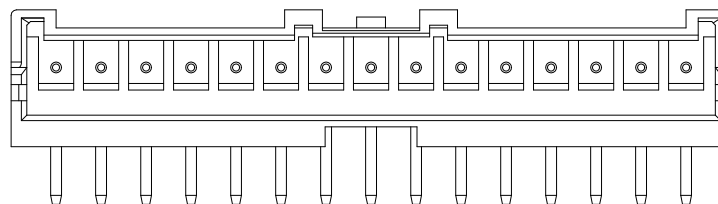

15Pin



2023/10/31	F1	/	Update borders	Larry Lin	Jack Zhang	GENERAL TOLERANCE .X ±0.30 .XX ±0.20 .XXX ±0.10 X.° ±2° PROJECT 	SMS 东莞市思索技术股份有限公司 Dongguan SESO Technology Co.,Ltd.				PART NO.				
2021/05/06	F	EN120210506001	Add new product type	TengMin	John Yang						2508WR-XXX-9TSNXX-X				
2021/03/31	E	EN120210331001	Add the specification with kink	Xin Qing	John Yang		APPROVAL	CHECK	DRAWN	DATE	TITLE				
DATE	REV	ECN NO.	DESCRIPTION	MODIFY	APPROVAL		Jack Zhang	Larry Yang	Larry Lin	2018/04/16	2.50 mm Crimp Style connectors				
										UNIT	SCALE	SHEET	REV	NUMBER	
										mm	1:1	2/2	F1	CD	

RoHS

This products can apply to the SESO Doc NO. QA-3-04-005 of Environmental&Material Management Rules

Poles	Dimensions (mm)		Poles	Dimensions (mm)	
	A	B		A	B
02	2.50	7.50	09	20.00	25.00
03	5.00	10.00	10	22.50	27.50
04	7.50	12.50	11	25.00	30.00
05	10.00	15.00	12	27.50	32.50
06	12.50	17.50	13	30.00	35.00
07	15.00	20.00	14	32.50	37.50
08	17.50	22.50	15	35.00	40.00

- Specifications :
- Voltage rating: 250V AC / DC
 - Current rating: 3A AC / DC
 - Withstanding voltage:1000V AC/minute
 - Temperature range: -40°C~+125°C
 - Insulation resistance:≥1000MΩ
 - Contact resistance: ≤10mΩ
 - After environmental testing: ≤20mΩ
 - Material(Pin):Brass
 - Mates With SESO Housing:2508H、2513H

2508 W R X-XX X- 9T SN X X
 ①① ①② ①③ ①④ ①⑤ ①⑥ ①⑦ ①⑧ ①⑨ ①⑩

- ① Series No.
- ② Category: W-Wafer
- ③ Connector Type: R-Right angle 90°
- ④ Mouting Type: Blank-DIP
- ⑤ Row No.-Pin No.: XX-02P~15P
- ⑥ Special No.:S-With post and with kink
 △ S1-With post and without kink
- ⑦ Material: 9T-PA9T UL94V-0
- ⑧ Plating Code: SN-Bright Tin Plating
 Underplate: Ni 40~120u"(1~3um) overall
 Top plating: Sn 80~200u"(2~5um) overall
- ⑨ Color : Blank-Natural color; GW-Grey
- ⑩ Packing : Blank-PE bag、T-Tray

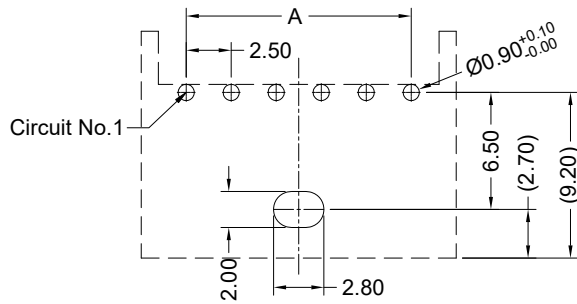
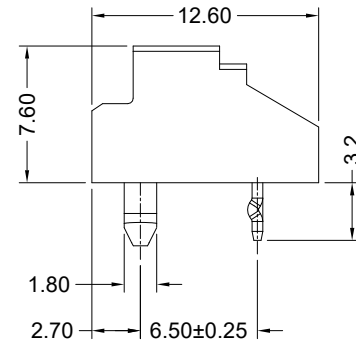
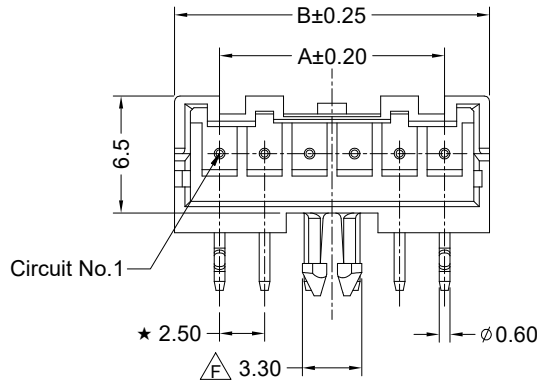
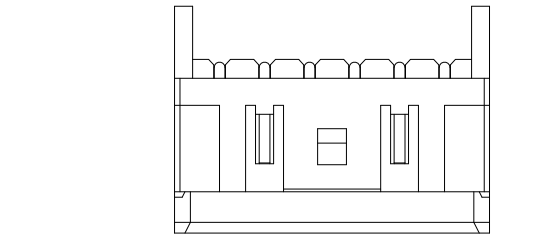

RECOMMENDED P.C.B LAYOUT T=1.60mm (TOLERANCE:±0.05)

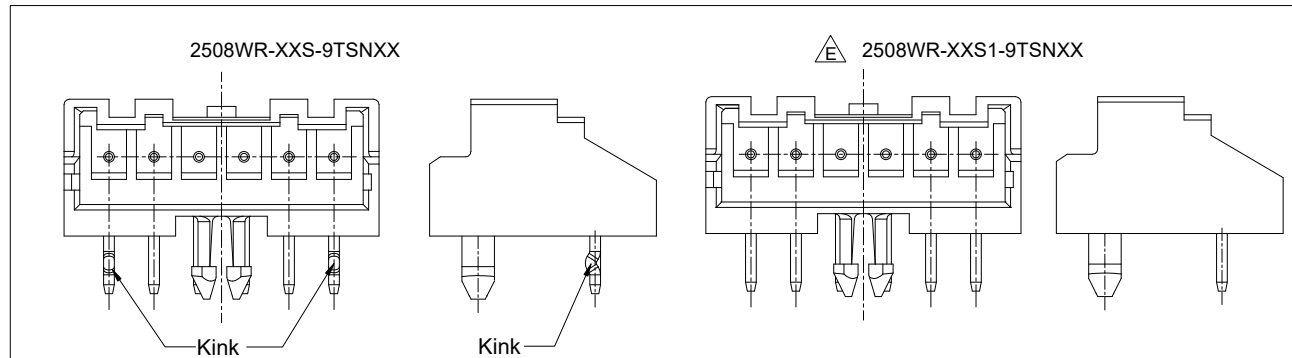

DATE	REV	ECN NO.	DESCRIPTION	MODIFY	APPROVAL
2023/10/31	F1	/	Update borders	Larry Lin	Jack Zhang
2021/05/06	F	EN120210506001	Modify the post structure	Cai Zhao	John Yang
2021/03/31	E	EN120210331001	Add the specification without kink	Xin Qing	John Yang

GENERAL TOLERANCE	
.X	±0.30
.XX	±0.20
.XXX	±0.10
X.°	±2°
PROJECT	
①	②

SMS 东莞市思索技术股份有限公司
 Dongguan SESO Technology Co.,Ltd.

APPROVAL	CHECK	DRAWN	DATE
Jack Zhang	Larry Yang	Larry Lin	2017/11/21

PART NO.				
2508WR-XXX-9T-SN-XXX				
TITLE				
2.50 mm Crimp Style connectors				
UNIT	SCALE	SHEET	REV	NUMBER
mm	1:1	1/2	F1	CD

RoHS

This products can apply to the SESO Doc NO. QA-3-04-005 of Environmental&Material Management Rules

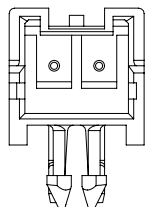

2Pin

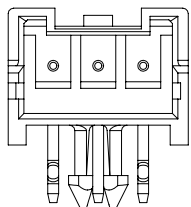

3Pin

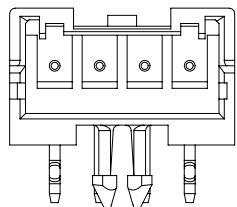

4Pin

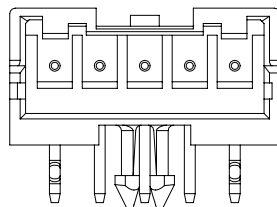

5Pin

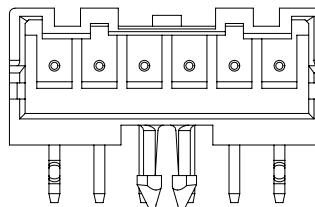

6Pin

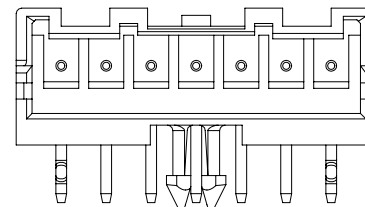

7Pin

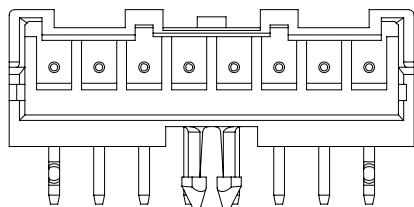

8Pin

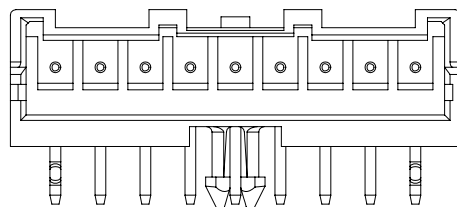

9Pin

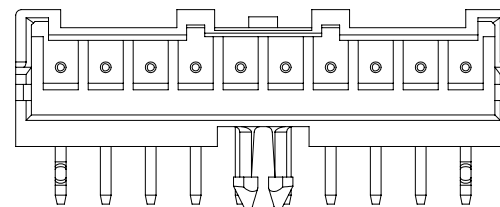

10Pin

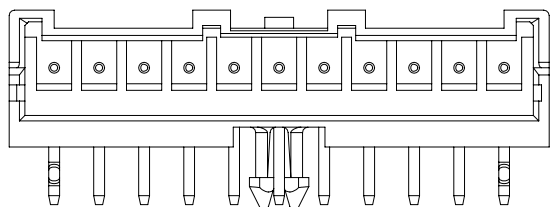

11Pin

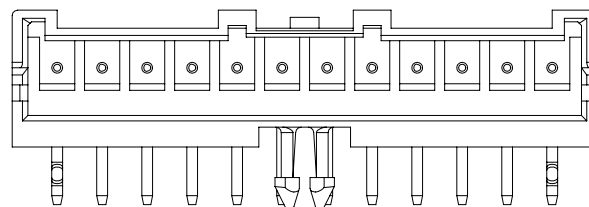

12Pin

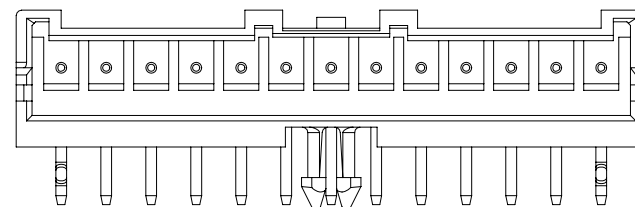

13Pin

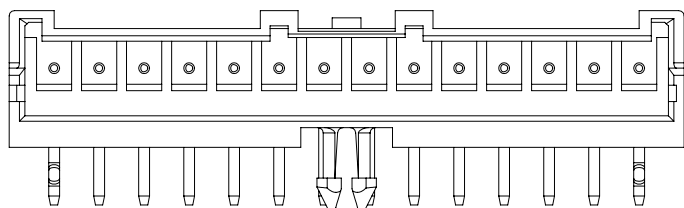

14Pin

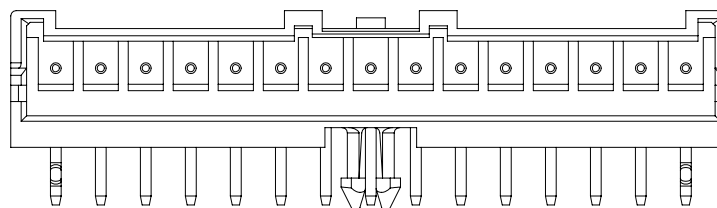

15Pin



2023/10/31	F1	/	Update borders	Larry Lin	Jack Zhang	GENERAL TOLERANCE .X ±0.30 .XX ±0.20 .XXX ±0.10 X.° ±2° PROJECT 	SMS 东莞市思索技术股份有限公司 Dongguan SESO Technology Co.,Ltd.	PART NO. 2508WR-XXX-9TSNXX				
2021/05/06	F	EN120210506001	Modify the post structure	Cai Zhao	John Yang			APPROVAL	CHECK	DRAWN	DATE	TITLE 2.50 mm Crimp Style connectors
2021/03/31	E	EN120210331001	Add the specification without kink	Xin Qing	John Yang			Jack Zhang	Larry Yang	Larry Lin	2017/11/21	UNIT mm
DATE	REV	ECN NO.	DESCRIPTION	MODIFY	APPROVAL			SCALE 1:1	SHEET 2/2	REV F1	NUMBER CD	

RoHS

This products can apply to the SESO Doc NO. QA-3-04-005 of Environmental&Material Management Rules



Poles	Dimensions/mm			
	A	B	C	D
2	2.50	5.75	10.00	4.05
3	5.00	8.25	12.50	5.75
4	7.50	10.75	15.00	9.20
5	10.00	13.25	17.50	11.35
6	12.50	15.75	20.00	13.85
7	15.00	18.25	22.50	16.35
8	17.50	20.75	25.00	18.85
9	20.00	23.25	27.50	21.35
10	22.50	25.75	30.00	23.85
11	25.00	28.25	32.50	26.35
12	27.50	30.75	35.00	28.85
13	30.00	33.25	37.50	31.35
14	32.50	35.75	40.00	33.85
15	35.00	38.25	42.50	36.35

Specifications:

- Voltage Rating:250V AC/DC
- Current Rating:3A AC/DC
- Withstanding Voltage:1000V AC/Minute
- Temperature Range:-40°C~+125°C
- Insulation Resistance:100MΩ Min./500V DC/Minute
- Contact Resistance:<10mΩ (Initial)
<20mΩ (After Testing)
- Mates With Housing:2508H-XX, 2513H-XX
- Product Specification:PS-2513-02
- Packaging Drawing:PK-2508WVS-XXE-9TXNX
- Symbols for SPC Dimensions:"★"

2508 W V S-XX E-9T X N X
① ② ③ ④ ⑤ ⑥ ⑦ ⑧ ⑨ ⑩

- ① Series No.:2508
- ② Category:W-Wafer
- ③ Connector Type:V-Straight 180°
- ④ Mounting Type:S-SMT
- ⑤ Row No.-Pin No.:
XX-Single Row-02Pin~15Pin
- ⑥ Special No.:E-Stamping Terminal
- ⑦ Plastic Material:9T-PA9T (UL94V-0)
- ⑧ Planting Code:SW1-Matte Tin
Underplate:Ni 40~120u"(1~3um) overall
Top Plating:Sn 80~200u"(2~5um) overall
- △ GW01-Underplate:Ni 40~120u"(1~3um) overall
Contact area Plating Au 1U"(0.025um)Min
Weld area Plating Sn 80~200u"(2~5um)
- ⑨ Color:N-Natural
- ⑩ Packing:X-R-Reel ; C-With Cap

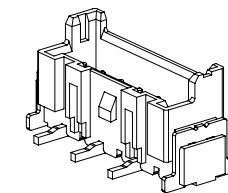
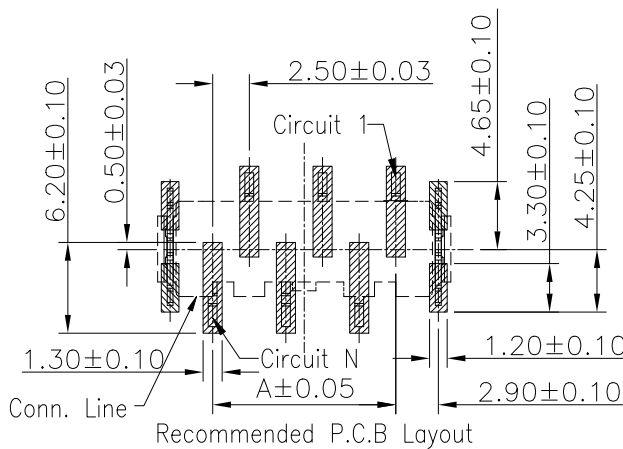
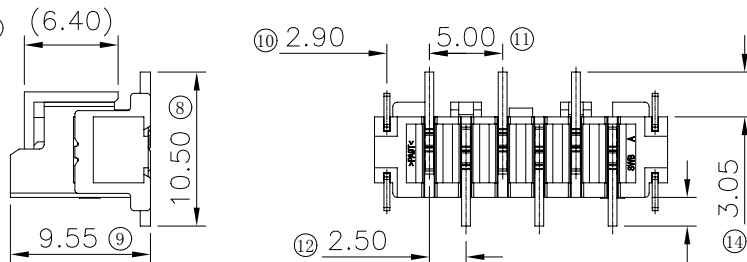
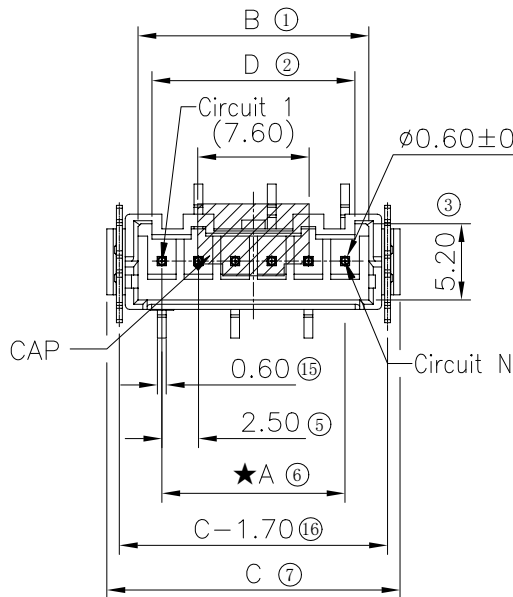
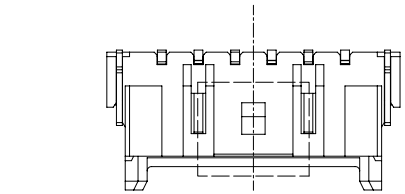

Without Cap

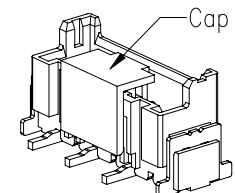

With Cap

20230706	B4	/	Modify the 3Pin size D according to the shell diagram	Zhou	Larry
20230630	B3	/	Increase the size ⑮ ⑯	Zhou	Larry
20230615	B2	/	ADD the CAP view	Zhou	Larry
DATE	REV	ECN NO.	DESCRIPTION	MODIFY	APPROVAL

GENERAL TOLERANCE	
.X	±0.35
.XX	±0.25
.XXX	±0.15
X.°	±2°
PROJECT	

SMS 东莞市思索技术股份有限公司
Dongguan SESO Technology Co.,Ltd.

APPROVAL	CHECK	DRAWN	DATE
Kevin	John Yang	Cai Zhao	2021/03/12

PART NO.				
2508WVS-XXE-9TXNX				
TITLE: 2.50mm WF				
ASSY vertical SMT				
UNIT	SCALE	SHEET	REV	NUMBER
mm	1:1	1/2	B4	CD

RoHS

This products can apply to the SESO Doc NO. QA-3-04-005 of Environmental&Material Management Rules



02 Pin

03 Pin

04 Pin

05 Pin

06~15 Pin

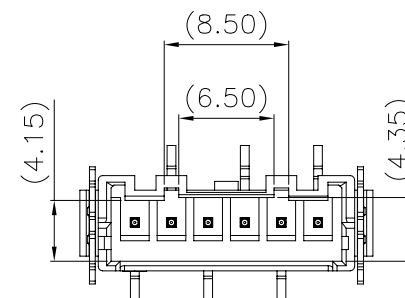
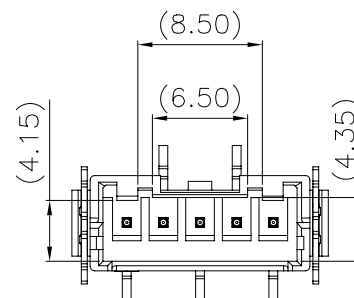
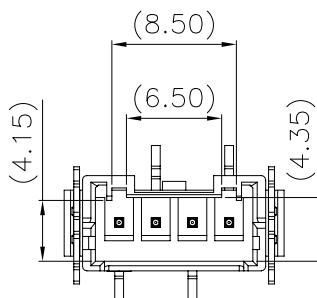
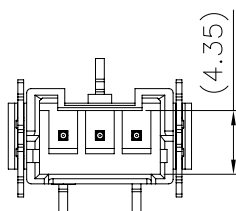
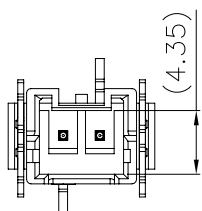
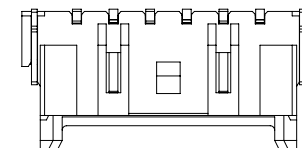
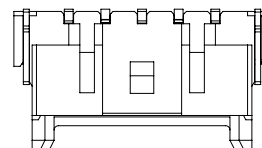
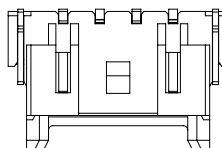
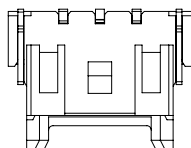
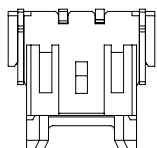

20230706	B4	/	Modify the 3Pin size D according to the shell diagram	Zhou	Larry	GENERAL TOLERANCE .X ±0.35 .XX ±0.25 .XXX ±0.15 X.° ±2° PROJECT 				SMS 东莞市思索技术股份有限公司 Dongguan SESO Technology Co.,Ltd.				PART NO. 2508WVS-XXE-9TXNX								
20230630	B3	/	Increase the size (15)(16)	Zhou	Larry									APPROVAL				TITLE: 2.50mm WF ASSY vertical SMT				
20230615	B2	/	ADD the CAP view	Zhou	Larry									Kevin	John Yang	Cai Zhao	2021/03/12	UNIT	SCALE	SHEET	REV	NUMBER
DATE	REV	ECN NO.	DESCRIPTION	MODIFY	APPROVAL													mm	1:1	2/2	B4	CD

RoHS

This products can apply to the SESO Doc NO. QA-3-04-005 of Environmental&Material Management Rules

- Specifications :
- Voltage rating: 250V AC / DC
 - Current rating: 3A AC / DC
 - Withstanding voltage:1000V AC/minute
 - Temperature range: -40°C~+125°C
 - Insulation resistance:≥1000MΩ
 - Contact resistance: ≤10mΩ
 - After environmental testing: ≤20mΩ
 - Material(Pin):Brass
 - Mates With SESO Housing:2508H

2508 W V X-XX XX- XX XX XX X
 ①②③④⑤⑥⑦⑧⑨⑩

- ① Series No.
- ② Category:W-WAFER
- ③ Welding Board Angle: V-Straight 180°
- ④ Welding Way: Blank-DIP
- ⑤ Row No.-Pin No.: XX-02P~15P
- ⑥ Special No.:
Blank-Without a boss、With Kink
N1-Without a boss、Without Kink
P- With a boss、With Kink
P1-With a boss、Without Kink
- ⑦ Material: 9T-PA9T 94V-0
- ⑧ Plating Category: SN-Bright Tin Plating
V01-Gold Flash
- ⑨ Color : Blank-Natural Color
- ⑩ Packing : Blank-Bag T-Tray C-Reel(With CAP)

Poles	Dimensions (mm)		Poles	Dimensions (mm)	
	A	B		A	B
02	2.50	7.50	09	20.00	25.00
03	5.00	10.00	10	22.50	27.50
04	7.50	12.50	11	25.00	30.00
05	10.00	15.00	12	27.50	32.50
06	12.50	17.50	13	30.00	35.00
07	15.00	20.00	14	32.50	37.50
08	17.50	22.50	15	35.00	40.00

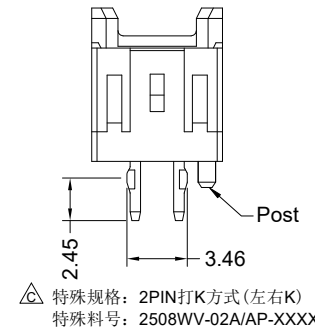
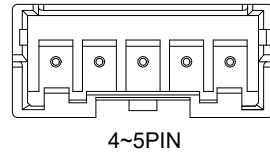
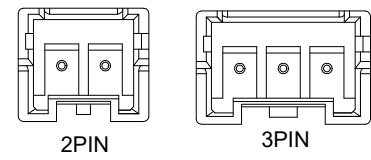
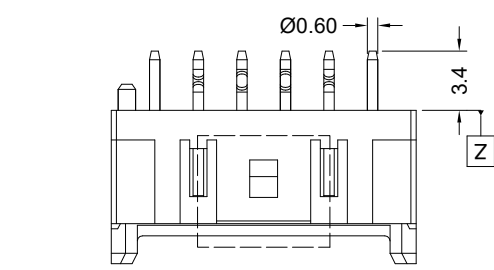

特殊规格: 2PIN打K方式(左右K)
 特殊料号: 2508WV-02A/AP-XXXX

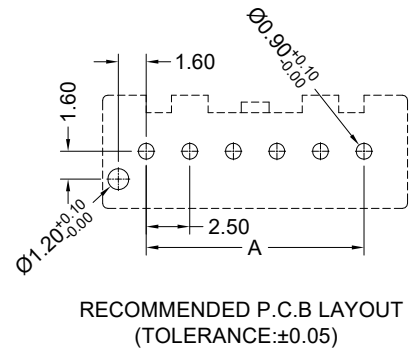
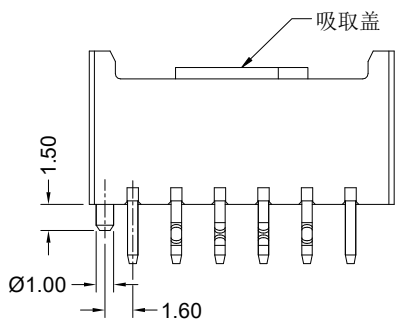
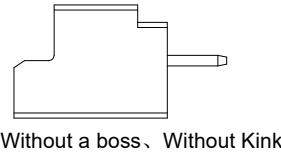
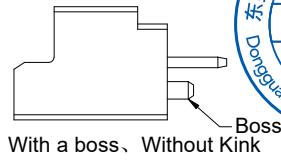
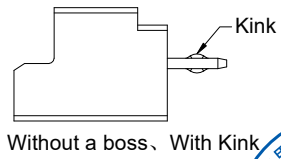
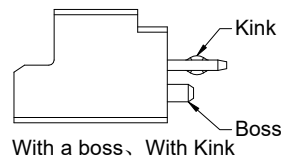
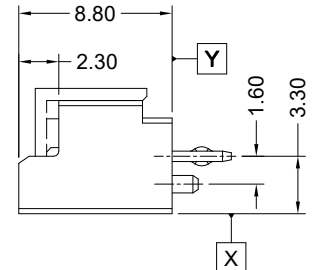
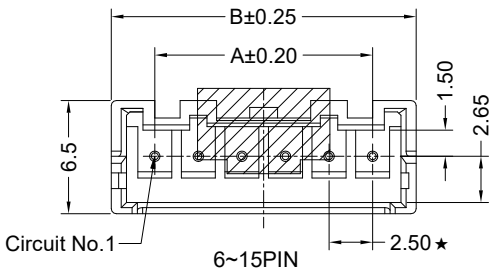

DATE	REV	ECN NO	DESCRIPTION	MODIFY	APPROVAL
2021/08/18	E	EN20210818002	Add with cap p/n	Mali	Alan qin

GENERAL TOLERANCE		APPROVAL	CHECK	DRAWN	DATE
.X	±0.30				
.XX	±0.20				
.XXX	±0.10				
X.°	±2°				
PROJECT		Jack Zhang	Larry Yang	Alan qin	2017/11/21

PART NO.				
2508WV-XXXX-9TXXXXX				
TITLE				
2.50 mm Crimp Style connectors				
UNIT	SCALE	SHEET	REV	NUMBER
mm	1:1	1/2	E	CD

SMS 东莞市思索技术股份有限公司
 Dongguan SESO Technology Co.,Ltd.

RoHS

This products can apply to the SESO Doc NO. QA-3-04-005 of Environmental&Material Management Rules



					GENERAL TOLERANCE .X ±0.30 .XX ±0.20 .XXX ±0.10 X.° ±2° PROJECT 				PART NO. 2508WV-XXXX-9TXXXXX TITLE 2.50 mm Crimp Style connectors					
2021/08/18	E	EN20210818002	Add with cap p/n	Mali	Alan qin	APPROVAL	CHECK	DRAWN	DATE	UNIT SCALE SHEET REV NUMBER mm 1:1 2/2 E CD				
DATE	REV	ECN NO	DESCRIPTION	MODIFY	APPROVAL	Jack Zhang	Larry Yang	Alan qin	2017/11/21					

