

RoHS

This products can apply to the SESO Doc NO. QA-3-04-005 of Environmental&Material Management Rules

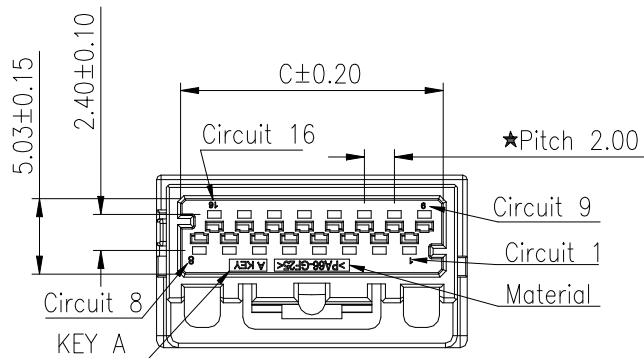

Specifications :

- Voltage rating: 60V AC/DC
- Current rating: 2A AC/DC
- Withstanding voltage: 1000V AC/minute
- Temperature range: $-40^{\circ}\text{C} \sim +125^{\circ}\text{C}$
- Insulation resistance: $\geq 100\text{M}\Omega$
- Contact resistance: $\leq 10\text{m}\Omega$
- After environmental testing: $\leq 20\text{m}\Omega$
- Mates With SESO terminal: 2045TXM-BSW1
- Mates With SESO Wafer: 2045WRS-2*XXX-10TSW1XR
- Symbols for SPC dimensions: " \star "
- Product Specification: PS-2045-01
- Packaging: see SESO drawing PK-204HM-2*XXX-NOXX

2045 H M-2*XX X -NO XX
 ① ② ③ ④ ⑤ ⑥ ⑦

- ① Series No.: 2045
- ② Category: H-HSG
- ③ Connector Type: M-Male
- ④ Row No.-Pin No.: 2*XX-Double Row-2*06~2*12Pin
- ⑤ Key code: A-Key A , B-Key B
- ⑥ Plastic Material: NO-PA66 UL94V-0
- ⑦ Color: BK-Black, GY-Gray

| DIM. PIN NO. | A | B | C |
|-----------------|-------|-------|-------|
| 2*06 | 15.40 | 17.50 | 16.70 |
| 2*08 | 19.40 | 21.50 | 20.70 |
| 2*10 | 23.40 | 25.50 | 24.70 |
| 2*12 | 27.40 | 29.50 | 28.70 |

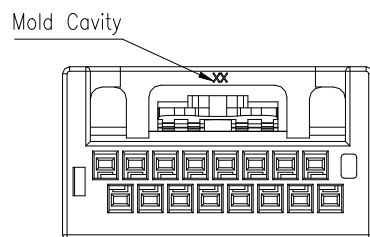
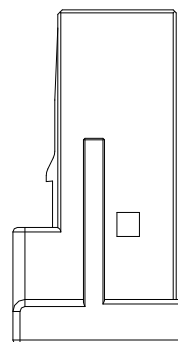
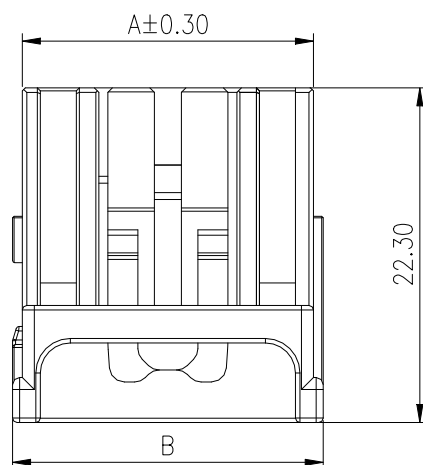
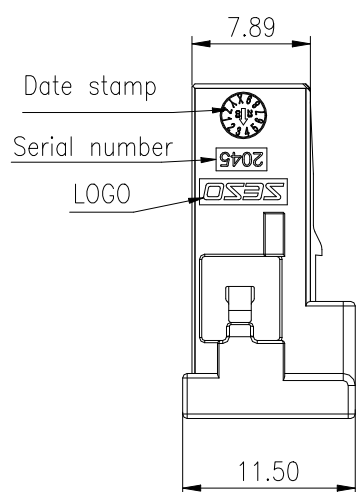

A

| | | | | | |
|----------|-----|---------|-----------------|----------|------------|
| 20240222 | X1 | / | version upgrade | Zee Wang | Jack Zhang |
| 20230224 | X0 | / | Initial release | Zee Wang | Jack Zhang |
| DATE | REV | ECN NO. | DESCRIPTION | MODIFY | APPROVAL |

| GENERAL TOLERANCE | |
|-------------------|------------|
| .X | ± 0.35 |
| .XX | ± 0.25 |
| .XXX | ± 0.15 |
| X. | $\pm 2'$ |
| PROJECT | |
| | |

SMS 东莞市思索技术股份有限公司
 Dongguan SESO Technology Co.,Ltd.

| APPROVAL | CHECK | DRAWN | DATE |
|------------|------------|----------|------------|
| Jack Zhang | Joshua Liu | Zee Wang | 2023/02/24 |

| PART NO. | | | | |
|--|-------|-------|-----|--------|
| 2045HM-2*XXX-NOXX | | | | |
| TITLE | | | | |
| 0.5mm Size, 2mm Pitch, Board Connector Housing | | | | |
| UNIT | SCALE | SHEET | REV | NUMBER |
| mm | 1:1 | 1/1 | X1 | CD |

1

2

3

4

5

6

7

8

RoHS

This products can apply to the SESO Doc NO. QA-3-04-005 of Environmental&Material Management Rules

2*06PIN

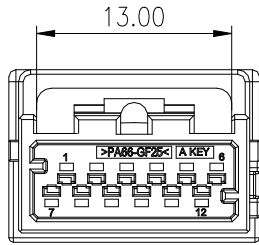

Key A

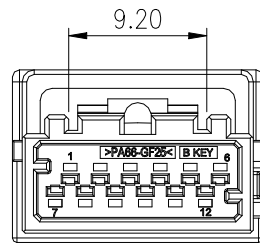

Key B

2*08PIN

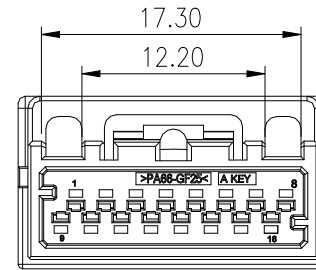

Key A

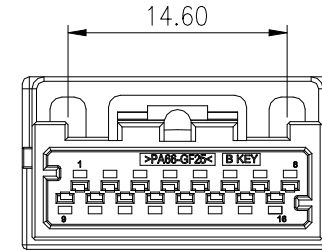

Key B



2*10PIN

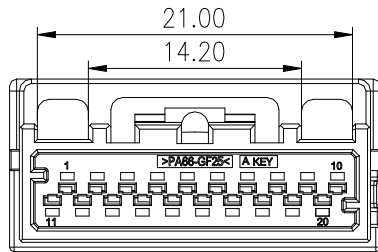

Key A

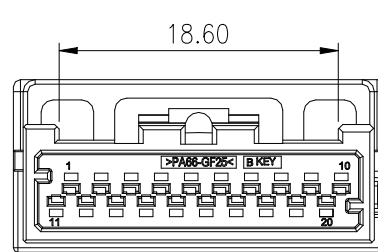

Key B

2*12PIN

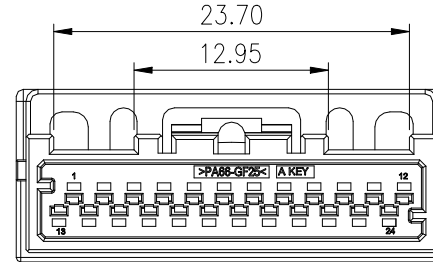

Key A

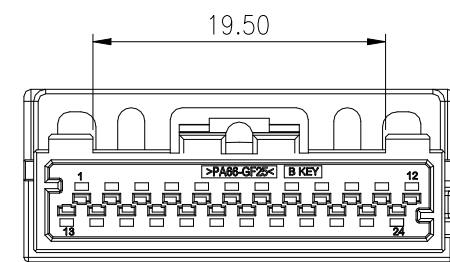

Key B

| | | | | | |
|----------|-----|---------|-----------------|----------|------------|
| 20240222 | X1 | / | version upgrade | Zee Wang | Jack Zhang |
| 20230224 | X0 | / | Initial release | Zee Wang | Jack Zhang |
| DATE | REV | ECN NO. | DESCRIPTION | MODIFY | APPROVAL |

| | |
|-------------------|-------|
| GENERAL TOLERANCE | |
| .X | ±0.35 |
| .XX | ±0.25 |
| .XXX | ±0.15 |
| X.* | ±2° |
| PROJECT | |
| | |

SMS 东莞市思索技术股份有限公司
Dongguan SESO Technology Co.,Ltd.

| | | | |
|------------|------------|----------|------------|
| APPROVAL | CHECK | DRAWN | DATE |
| Jack Zhang | Joshua Liu | Zee Wang | 2023/02/24 |

| | | | | |
|--|-------|-------|-----|--------|
| PART NO. | | | | |
| 2045HM-2*XXX-NOXX | | | | |
| TITLE | | | | |
| 0.5mm Size, 2mm Pitch, Board Connector Housing | | | | |
| UNIT | SCALE | SHEET | REV | NUMBER |
| mm | 1:1 | 1/1 | X1 | CD |

RoHS

This products can apply to the SESO Doc NO. QA-3-04-005 of Environmental&Material Management Rules

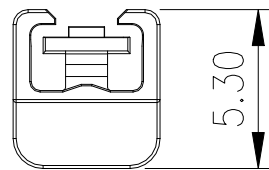
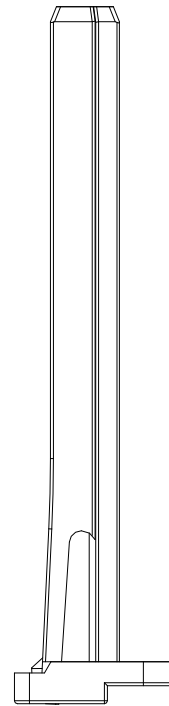
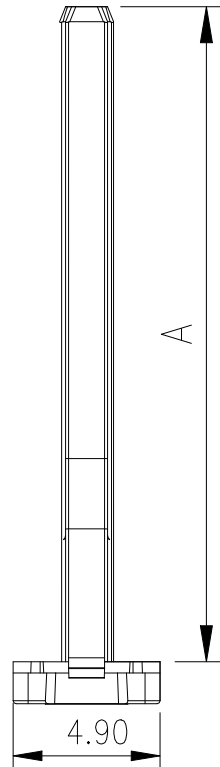

■ Specifications :

- Voltage rating: 60V AC/DC
- Current rating: 2A AC/DC
- Withstanding voltage: 1000V AC/minute
- Temperature range: -40°C~+125°C
- Insulation resistance: ≥100MΩ
- Contact resistance: <10mΩ
- After environmental testing: <20mΩ
- Mates With SESO Housing: 2045HM-2*XXX-NOXX
- Product Specification: PS-2045-01
- Packaging: see SESO drawing PK-2045C-2*XX-N0BK

2045 C-2*XX -NO BK

① ② ③ ④ ⑤

- ① Series No.:2045
- ② Category:C-TPA
- ③ Row No.-Pin No.:2*XX-Double Row-2*06~2*12Pin
- ④ Plastic Material:NO-PA66 UL94V-0
- ⑤ Color:BK-Black

| DIM. PIN NO. | A |
|-----------------|-------|
| 2*06 | 13.85 |
| 2*08 | 17.85 |
| 2*10 | 21.85 |
| 2*12 | 25.85 |

| DATE | REV | ECN NO. | DESCRIPTION | MODIFY | APPROVAL |
|----------|-----|---------|-----------------|----------|------------|
| 20240124 | X1 | / | version upgrade | Zee Wang | Jack Zhang |
| 20230224 | X0 | / | Initial release | Zee Wang | Jack Zhang |

GENERAL TOLERANCE

| | |
|---------|-------|
| .X | ±0.35 |
| .XX | ±0.25 |
| .XXX | ±0.15 |
| X.' ±2' | |

PROJECT:

SMS 东莞市思索技术股份有限公司
Dongguan SESO Technology Co.,Ltd.

| | | | |
|------------|------------|----------|------------|
| APPROVAL | CHECK | DRAWN | DATE |
| Jack Zhang | Joshua Liu | Zee Wang | 2023/02/24 |

PART NO. 2045C-2*XX-N0BK

TITLE 0.5mm Size, 2mm Pitch, Board Connector TPA

| UNIT | SCALE | SHEET | REV | NUMBER |
|------|-------|-------|-----|--------|
| mm | 1:1 | 1/1 | X1 | CD |

RoHS This products can apply to the SESO Doc NO. QA-3-04-005 of Environmental&Material Management Rules

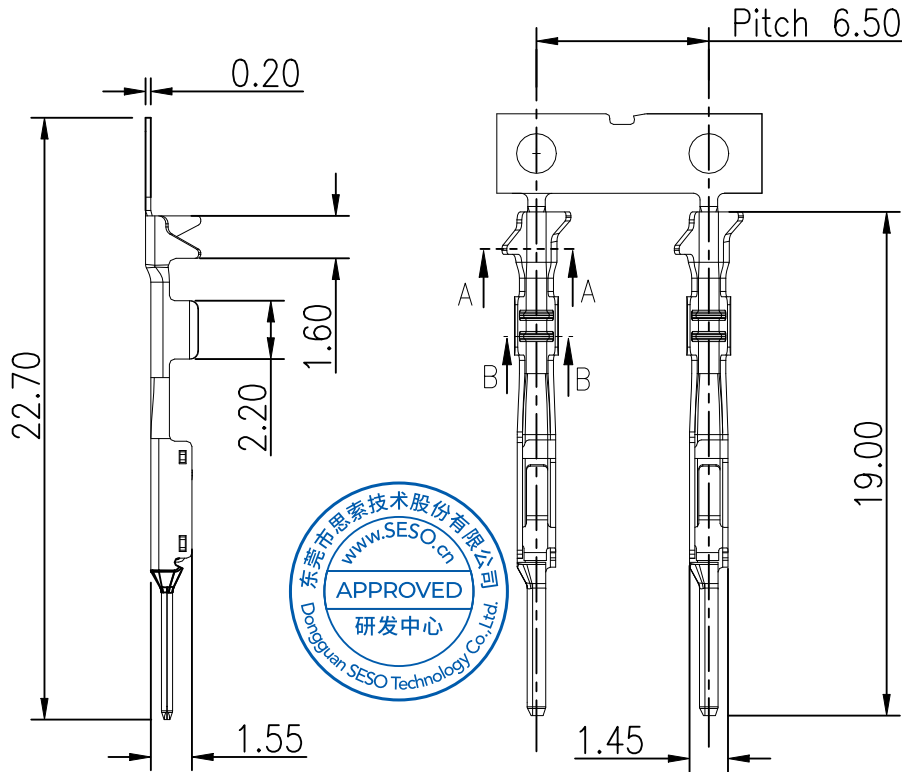

■ Specifications :

- Voltage rating: 60V AC/DC
- Current rating: 2A Max. AC/DC
- Withstanding voltage: 1000V AC/minute
- Temperature range: -40°C~+125°C
- Insulation resistance: ≥100MΩ
- Contact resistance: ≤10mΩ
- After environmental testing: ≤20mΩ
- Mates With SESO Housing: 2045HM-2*XXX-NOXX
- Product Specification: PS-2045-01
- Packaging: see SESO drawing PK-2045TXM-BSW1

2045 I X M-B SW1

① ② ③ ④ ⑤ ⑥

- ① Series No.:2045
- ② Category:T-Terminal
- ③ Appearance type:Blank-Ordinary; L-Low feet
- ④ Connector Type:M-Male
- ⑤ Material: B-Brass
- ⑥ Plating Code: SW1-Matte Tin
Underplate:Ni 40~120u"(1~3um) overall
Top Plating:Sn 80~200u"(2~5um) overall

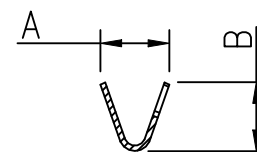

SECTION A-A
SCALE 1:1

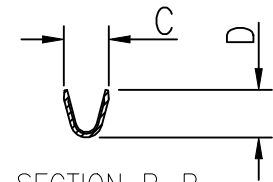

SECTION B-B
SCALE 1:1

| | | | | | | | |
|--------------|----------|--|-----------------|-------|-------|-------|-------|
| 2045TM-BSW1 | Brass | AWG#22~24 (0.22~0.35mm ²) | Ø1.40mm Max | 2.60 | 2.60 | 1.70 | 1.80 |
| 2045TLM-BSW1 | | AWG#26~28 (0.08~0.13mm ²) | Ø1.20mm Max | 2.60 | 2.10 | 1.60 | 1.70 |
| P/N | Material | Wire | insulation O.D. | DIM A | DIM B | DIM C | DIM D |

| | | | | | | | |
|----------|-----|---------|-----------------|----------|------------|--|--|
| 20230928 | X1 | / | version upgrade | Zee Wang | Jack Zhang | | |
| 20230224 | X0 | / | Initial release | Zee Wang | Jack Zhang | | |
| DATE | REV | ECN NO. | DESCRIPTION | MODIFY | APPROVAL | | |

| | |
|-------------------|-------|
| GENERAL TOLERANCE | |
| .X | ±0.35 |
| .XX | ±0.25 |
| .XXX | ±0.15 |
| X. | ±2° |
| PROJECT | |

SMS 东莞市思索技术股份有限公司
Dongguan SESO Technology Co.,Ltd.

| | | | |
|------------|------------|----------|------------|
| APPROVAL | CHECK | DRAWN | DATE |
| Jack Zhang | Joshua Liu | Zee Wang | 2023/02/24 |

| | | | | |
|---|-------|-------|-----|--------|
| PART NO. 2045TXM-BSW1 | | | | |
| TITLE 0.5mm Size, 2mm Pitch, Board Connector Terminal | | | | |
| UNIT | SCALE | SHEET | REV | NUMBER |
| mm | 1:1 | 1/1 | X1 | CD |

RoHS This products can apply to the SESO Doc NO. QA-3-04-005 of Environmental&Material Management Rules

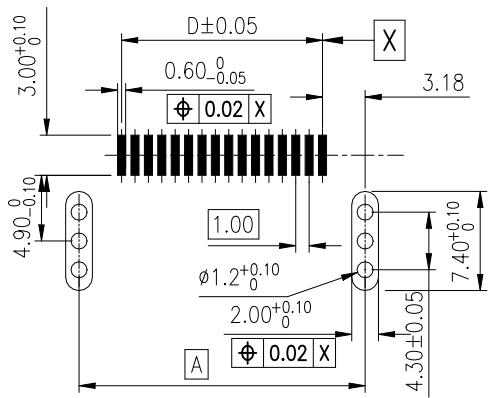
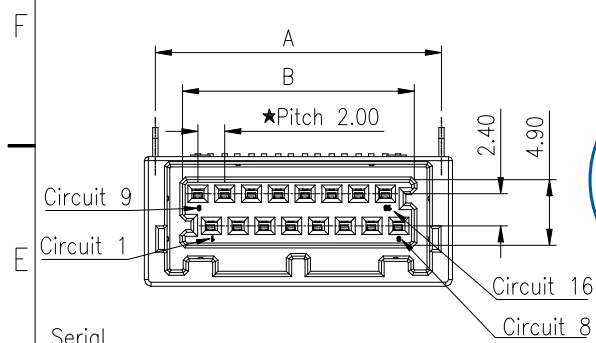

Recommended P.C.B LAYOUT
General Tolerance±0.05

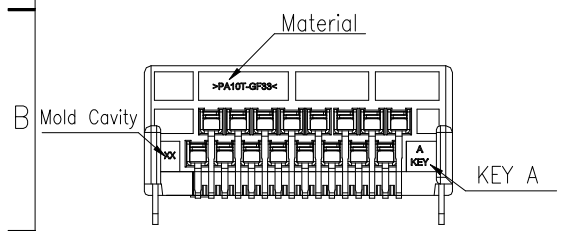
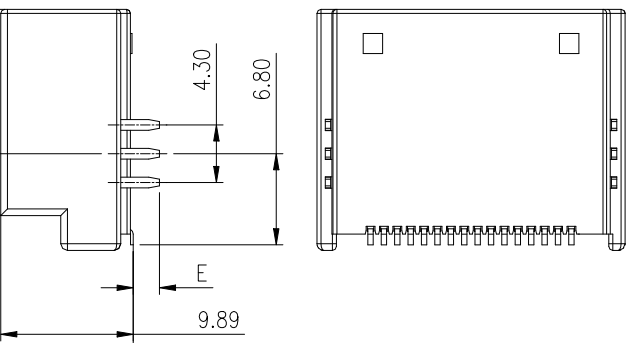
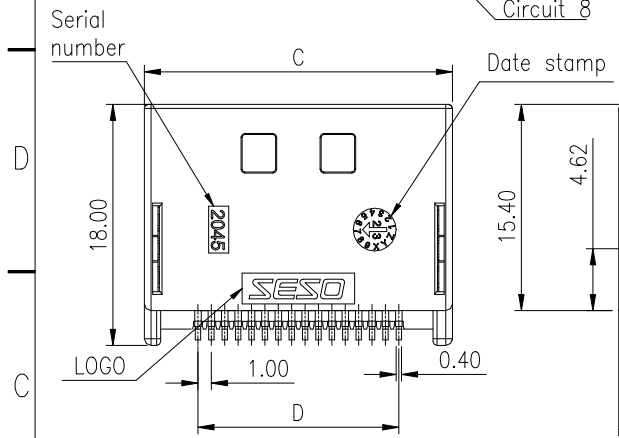

Specifications :

- Voltage rating: 60V AC/DC
- Current rating: 2A AC/DC
- Withstanding voltage: 1000V AC/minute
- Temperature range: -40°C~+125°C
- Insulation resistance: >100MΩ
- Contact resistance: <10mΩ
- After environmental testing: <20mΩ
- Material(Pin): Copper alloy
- Mates With SESO Housing: 2045HM-2*XXX-NOXX
- Symbols for SPC dimensions: "★"
- Product Specification: PS-2045-01
- Packaging: see SESO drawing:
PK-2045WRS-2*XXXX-10TSW1XR

2045 W R S - 2 * XX X X - 10T SW1 X R
① ② ③ ④ ⑤ ⑥ ⑦ ⑧ ⑨ ⑩ ⑪

- ① Series No.:2045
- ② Category:W-Wafer
- ③ Connector Type:R-Right Angle 90°
- ④ Mounting Type:S-SMT
- ⑤ Row No.-Pin No.:2*XX-Double Row-2*06~2*12Pin
- ⑥ Key code: A-Key A , B-Key B
- ⑦ Special code:blank-E:1.10; L-E:1.96
- ⑧ Plastic Material:10T-PA10T UL94V-0
Plating Code:SW1-Matte Tin
Underplate:Ni 40~120u"(1~3um) overall
- ⑨ Top Plating:Sn 80~200u"(2~5um) overall
- ⑩ Color:B-Black,G-Gray
- ⑪ Packing:R-Reel

| DIM. PIN NO. | A | B | C | D |
|-----------------|-------|-------|-------|-------|
| 2*06 | 17.36 | 13.30 | 19.00 | 11.00 |
| 2*08 | 21.36 | 17.30 | 23.00 | 15.00 |
| 2*10 | 25.36 | 21.30 | 27.00 | 19.00 |
| 2*12 | 29.36 | 25.30 | 31.00 | 23.00 |

| PART NO. | E |
|------------------------|------|
| 2045WRS-2*XX-10TSW1XR | 1.10 |
| 2045WRS-2*XXL-10TSW1XR | 1.96 |

| DATE | REV | ECN NO. | DESCRIPTION | MODIFY | APPROVAL | GENERAL TOLERANCE | APPROVAL | | | | PART NO. | | | | | |
|----------|-----|---------------|--------------------------|----------|------------|---|--|------------|----------|------------|----------|----------|-------|-----|--------|--|
| 20240309 | X2 | EN20240309001 | New specifications added | Zee Wang | Jack Zhang | .X ±0.35 | 东莞市思索技术股份有限公司 Dongguan SESO Technology Co.,Ltd. | APPROVAL | CHECK | DRAWN | DATE | PART NO. | | | | |
| 20240221 | X1 | / | version upgrade | Zee Wang | .XX ±0.25 | 2045WRS-2*XXXX-10TSW1XR | | | | | | | | | | |
| 20230224 | X0 | / | Initial release | Zee Wang | .XXX±0.15 | TITLE 0.5mm Size, 2mm Pitch, Board Connector WF | | | | | | | | | | |
| | | | | | | X: ±2 | Jack Zhang | Joshua Liu | Zee Wang | 2023/02/24 | UNIT | SCALE | SHEET | REV | NUMBER | |
| | | | | | | PROJECT | | | | | mm | 1:1 | 1/1 | X2 | CD | |

RoHS

This products can apply to the SESO Doc NO. QA-3-04-005 of Environmental&Material Management Rules

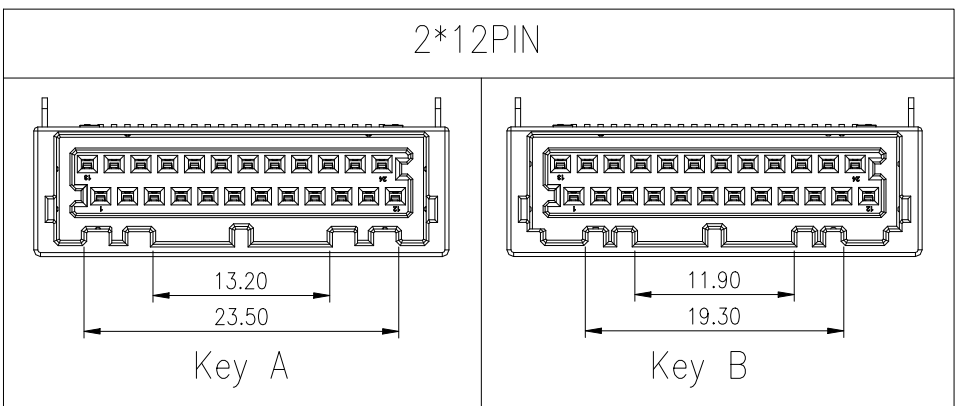
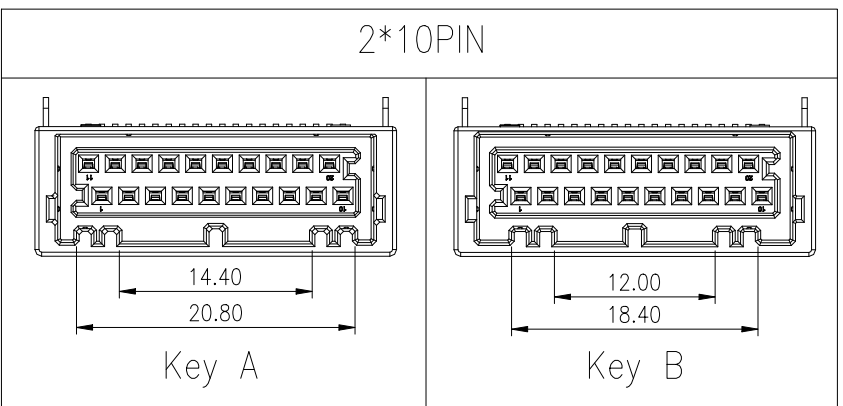
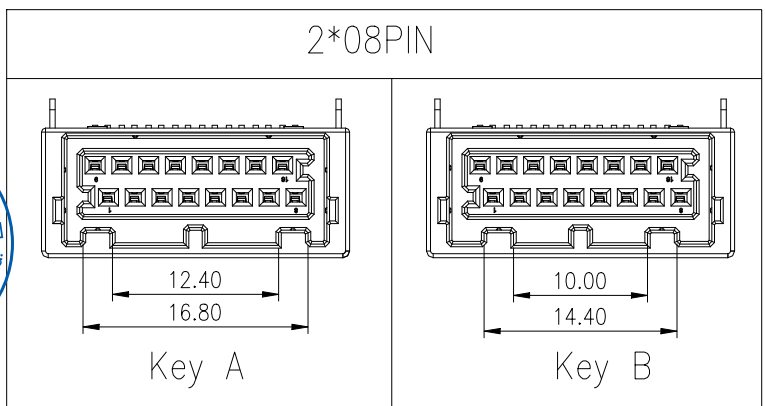
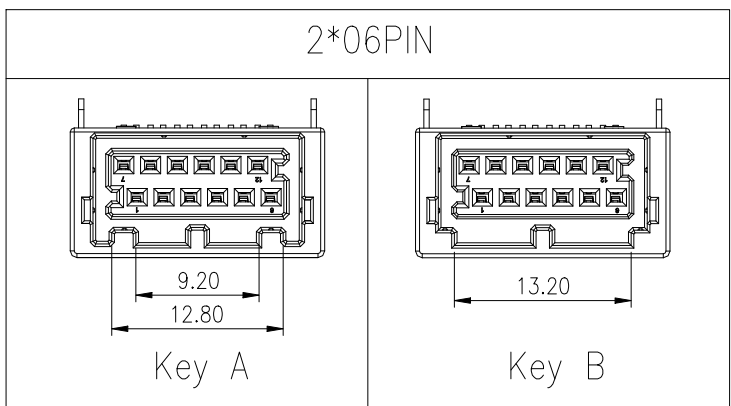

| | | | | | | | | | | | | | | | |
|----------|-----|---------------|--------------------------|----------|--------------|--|---|------------|----------|------------|---|--|--|--|--|
| 20240309 | X2 | EN20240309001 | New specifications added | Zee Wang | Jack Zhang | GENERAL TOLERANCE .X ±0.35 .XX ±0.25 .XXX±0.15 X: ±2 PROJECT | SMS 东莞市思索技术股份有限公司 Dongguan SESO Technology Co.,Ltd. | | | | PART NO. 2045WRS-2*XXXX-10TSW1XR | | | | |
| 20240221 | X1 | / | version upgrade | Zee Wang | Jack Zhang | | | | | | TITLE 0.5mm Size, 2mm Pitch, Board Connector WF | | | | |
| 20230224 | X0 | / | Initial release | Zee Wang | Zhonghua Liu | | APPROVAL | CHECK | DRAWN | DATE | UNIT mm SCALE 1:1 SHEET 1/1 REV X2 NUMBER CD | | | | |
| DATE | REV | ECN NO. | DESCRIPTION | MODIFY | APPROVAL | | Jack Zhang | Joshua Liu | Zee Wang | 2023/02/24 | | | | | |