

RoHS

This products can apply to the SESO Doc NO. QA-3-04-005 of Environmental&Material Management Rules

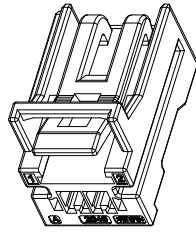
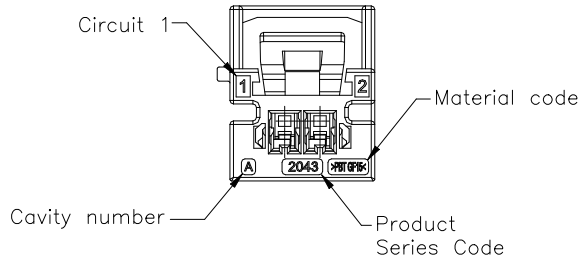

Specifications :

- Voltage rating: 50V Max. AC / DC
- Current rating: 4A Max.AC / DC
- Withstanding voltage: 1000V AC/minute
- Temperature range: -40°C~+125°C
- Insulation resistance: 100MΩ Min
- Contact resistance: 25mΩ Max.
- Material(Retainer): PBT
- Mates With SESO Terminal: 2043TXF
- Symbols "★" For SPC Dimensions
- Product Specification: PS-2043-01
- Packaging: See Drawing: PK-2043AM-XXX-PTXX

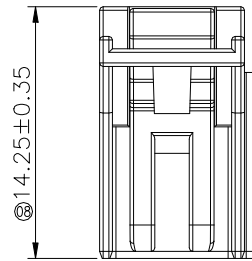
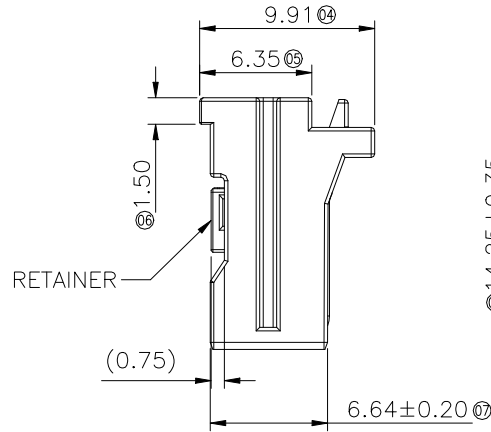
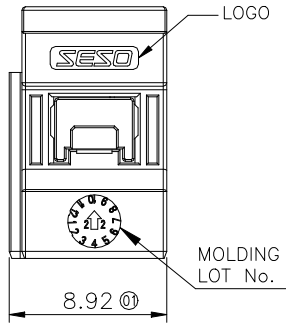

2043 A M - 02 X- PT XX  
① ② ③ ④ ⑤ ⑥ ⑦

- ① Series No.
- ② Category: TPA Pre-Assembly Housing
- ③ Connector Type: Male Housing
- ④ Row No.-Pin No: 02-02P
- ⑤ Key Code:  
A-Key A ,B-Key B ,C-Key C , D-Key D
- ⑥ Plastic material: PT-PBT UL94V-0
- ⑦ Color:  
BK-Black , GY-Gray , DG-Dark Grey , GR-Green

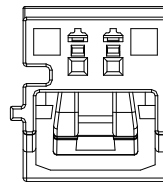
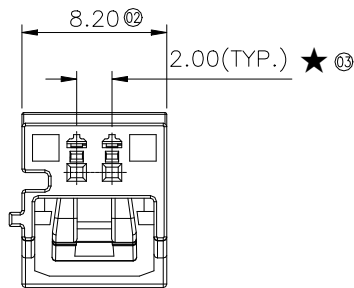

KEY A  
Black

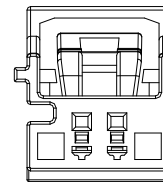

KEY B  
Gray

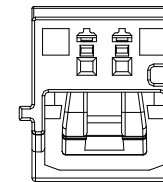

KEY C  
Dark Gray

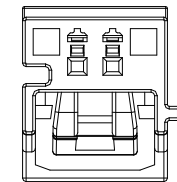

KEY D  
Green

					<b>SMS</b> 东莞市思索技术股份有限公司 Dongguan SESO Technology Co.,Ltd.				PART NO. 2043AM-02X-PTXX											
GENERAL TOLERANCE					APPROVAL				CHECK				DRAWN				DATE			
.X ±0.35					Jack Zhang				Yangmeng				Joshua				2023/04/11			
.XX ±0.25																				
.XXX ±0.15																				
X.° ±2°																				
PROJECT																				
20230703 X1 / Key A Description modification Joshua Larry Yang					20230411 X0 / Initial release Joshua Larry Yang					UNIT mm SCALE 1:1 SHEET 1/1 REV X1 NUMBER CD					TITLE 2.00mm Pitch Male Housing					
DATE REV ECN NO. DESCRIPTION MODIFY APPROVAL																				

RoHS

This products can apply to the SESO Doc NO. QA-3-04-005 of Environmental&Material Management Rules

Specifications :

- Voltage rating: 50V Max. AC / DC
- Current rating: 4A Max.AC / DC
- Withstanding voltage: 1000V AC/minute
- Temperature range: -40°C~+125°C
- Insulation resistance: 100MΩ Min
- Contact resistance: 25mΩ Max.
- Material(Retainer): PBT
- Mates With SESO Terminal: 2043TXF
- Symbols "★"For SPC Dimensions
- Product Specification: PS-2043-01
- Packaging: See Drawing: PK-2043AM-XXX-PTXX

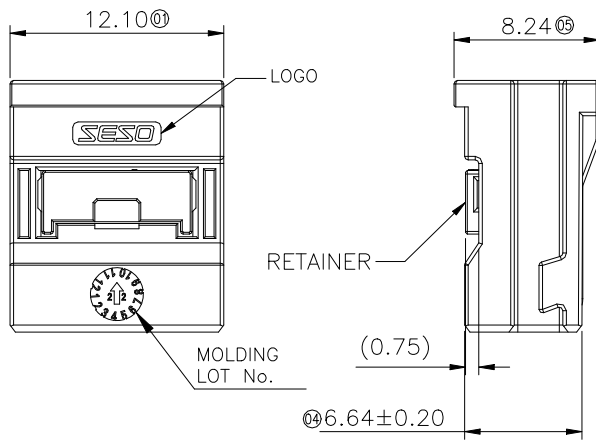
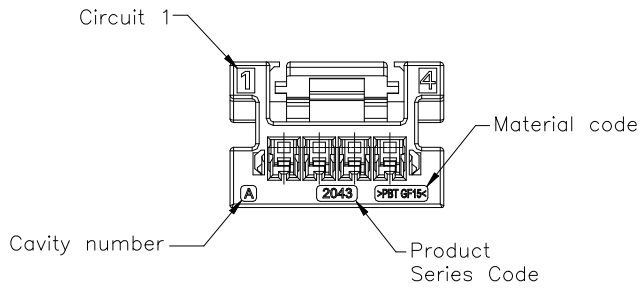
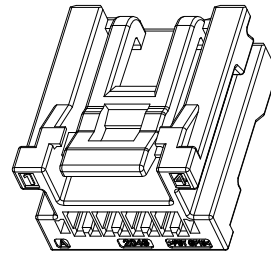

2043 A M - 04 X- PT XX  
 ① ② ③ ④ ⑤ ⑥ ⑦

- ① Series No.
- ② Category: TPA Pre-Assembly Housing
- ③ Connector Type: Male Housing
- ④ Row No.-Pin No: 04-04P
- ⑤ Key Code:  
A-Key A ,B-Key B ,C-Key C , D-Key D
- ⑥ Plastic material: PT-PBT UL94V-0
- ⑦ Color:  
BK-Black , GY-Gray , DG-Dark Grey , GR-Green

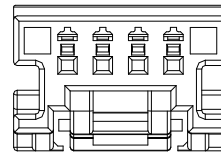
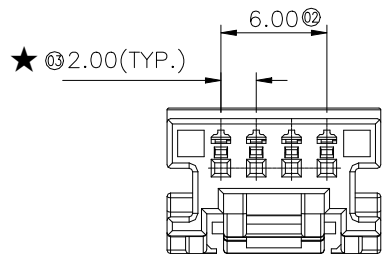

KEY A  
Black

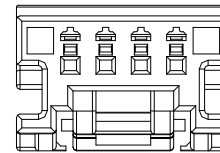

KEY B  
Gray

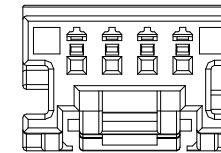

KEY C  
Dark Gray

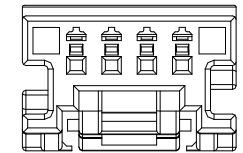

KEY D  
Green

					<p>GENERAL TOLERANCE</p> <p>.X ±0.35</p> <p>.XX ±0.25</p> <p>.XXX ±0.15</p> <p>X.° ±2°</p> <p>PROJECT</p>				<p>PART NO. 2043AM-04X-PTXX</p> <p>TITLE 2.00mm Pitch Male Housing</p>					
20230703	X1	/	Key A Description modification	Joshua	Larry Yang	APPROVAL	CHECK	DRAWN	DATE	UNIT	SCALE	SHEET	REV	NUMBER
20230411	X0	/	Initial release	Joshua	Larry Yang					mm	1:1	1/1	X1	CD
DATE	REV	ECN NO.	DESCRIPTION	MODIFY	APPROVAL	Jack Zhang	Yangmeng	Joshua	2023/04/11					

**SMS** 东莞市思索技术股份有限公司  
 Dongguan SESO Technology Co.,Ltd.



RoHS

This products can apply to the SESO Doc NO. QA-3-04-005 of Environmental&Material Management Rules

Specifications:

- Current Rating: 4A AC/DC(0.35mm<sup>2</sup> Wire)
- Temperature Range: -40°C~+125°C
- Contact Resistance: <math>\leq 25m\Omega</math>(After Testing)
- Mates With SESO Housing: 2043AM-XXX
- Packaging Drawing: PK-2043TF-XXX
- Product Specification: PS-2043-01
- Symbols for SPC Dimensions: "★"

2043 I X F - H X X  
① ②③④ ⑤ ⑥⑦

- ① Series No.: 2043
- ② Category: T-Terminal
- ③ Shape: Blank-Common Feet ;  
L-Low Feet
- ④ Connector Type: F-Female terminal
- ⑤ Material: H-LV214 Material
- ⑥ Plating Code: Y2-40~120u"(1~3um) TIN  
GW30-Underplate Ni 30u"(0.75um) Min;  
Area 1 contact point plating Au 30u"(0.75um) Min
- ⑦ Plating Process: B-Stamping After Plating  
Blank-Stamping Before Plating

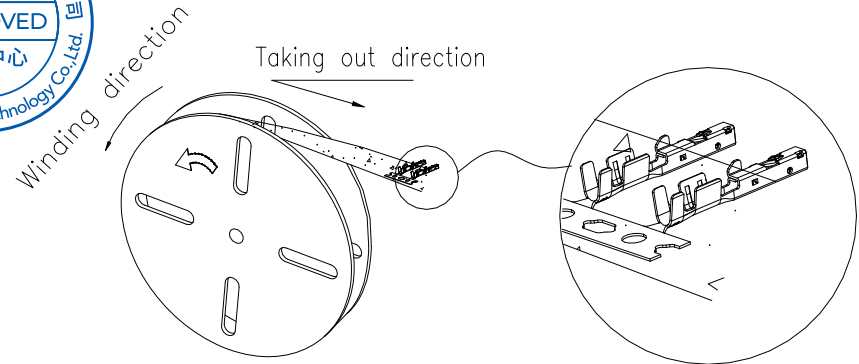
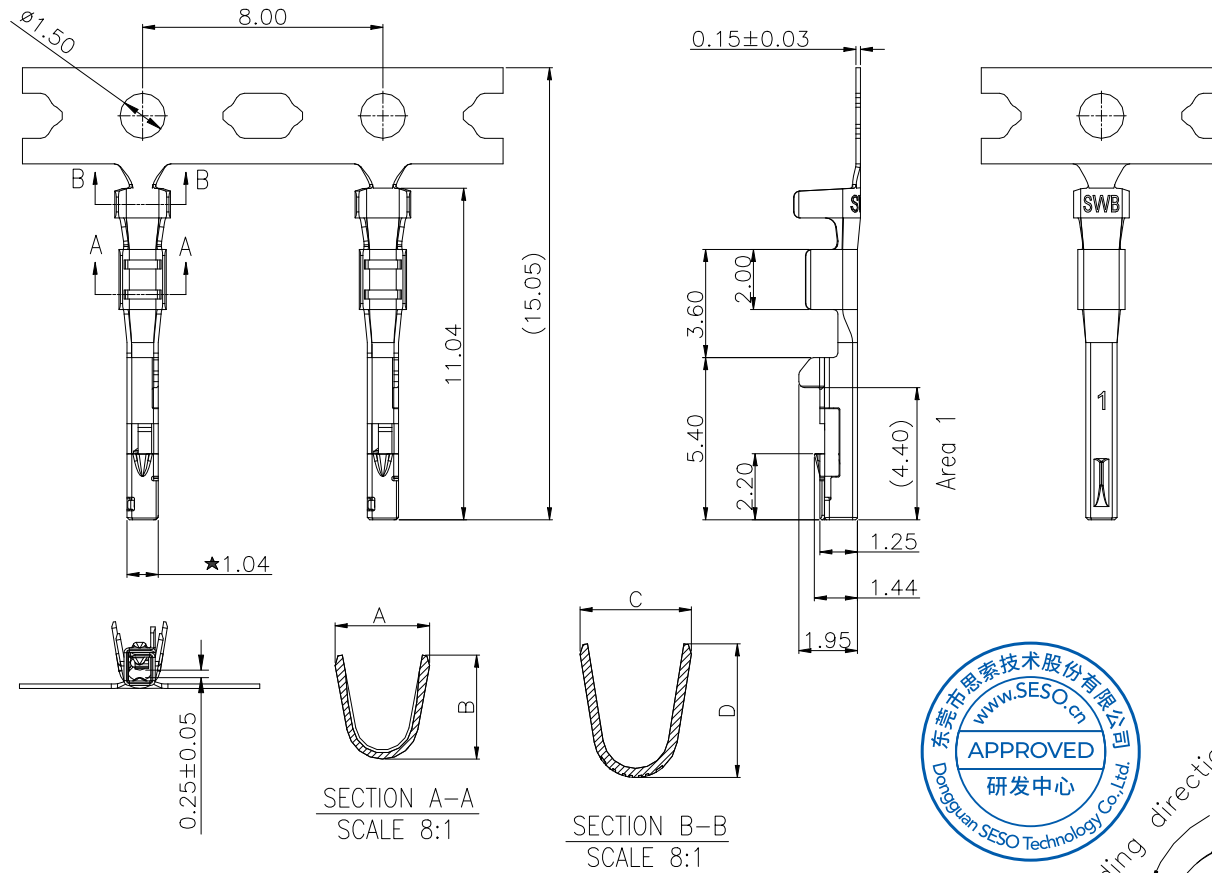

2043TLF-HXX	AWG#30~26 (0.05~0.13mm <sup>2</sup> )	∅0.9mm Max	1.14	1.13	1.36	1.56
2043TF-HXX	AWG#24~22 (0.22~0.35mm <sup>2</sup> )	∅1.3mm Max	1.57	1.73	1.85	2.22
2043THF-HXX	AWG#20 (0.50mm <sup>2</sup> )	∅1.4mm Max	2.20	2.20	2.50	2.30
Part NO.	Wire Range	Insulation O.D.	DIM A	DIM B	DIM C	DIM D

20231201	X1	/	Add Plating	Joshua	Jack Zhang
20230411	X0	/	Initial release	Joshua	Jack Zhang
DATE	REV	ECN NO.	DESCRIPTION	MODIFY	APPROVAL

GENERAL TOLERANCE	
.X	±0.35
.XX	±0.25
.XXX	±0.15
X.' ±2'	
PROJECT	
Jack Zhang	Yangmeng

**SMS** 东莞市思索技术股份有限公司  
Dongguan SESO Technology Co.,Ltd.

APPROVAL	CHECK	DRAWN	DATE
Jack Zhang	Yangmeng	Joshua	2023/04/11

PART NO. 2043TF-HXX				
TITLE 2.00mm Female Terminal				
UNIT	SCALE	SHEET	REV	NUMBER
mm	4:1	1/1	X1	CD

RoHS

This products can apply to the SESO Doc NO. QA-3-04-005 of Environmental&Material Management Rules

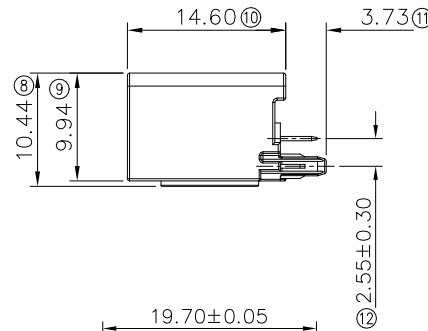
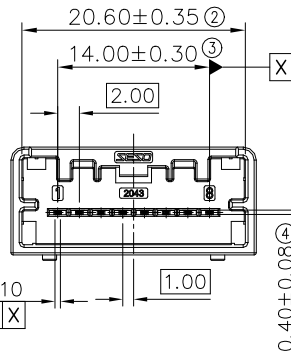
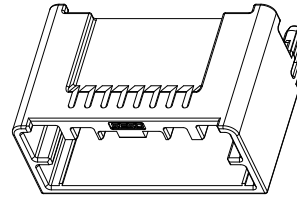
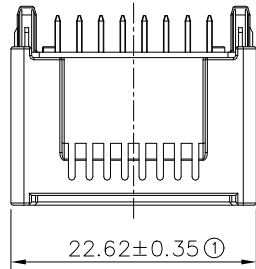

★ ⑥ 0.50 ± 0.10  
⑤  $\phi$  0.40 X

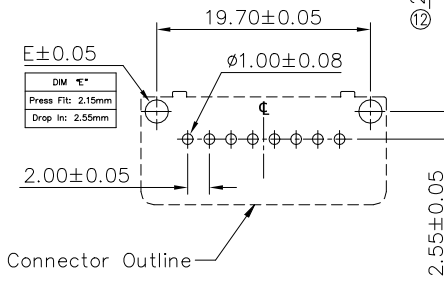

APPLICABLE P.C.B LAYOUT(REF.)  
P.C.B THICKNESS t=1.6mm

Specifications :

- Voltage rating: 50V Max. AC / DC
- Current rating: 4A Max.AC / DC
- Withstanding voltage: 1000V AC/minute
- Temperature range: -40°C~+125°C
- Insulation resistance: 100M $\Omega$
- Contact resistance: 25m $\Omega$  Max.
- Material(Pin): Brass
- Mates With SESO Housing: 2043AM
- Symbols "★" For SPC Dimensions
- Product Specification: PS-2043-01
- Packaging: See Drawing:  
PK-2043WV-XXPX-SSSW1XT

2043 W V - 08 P X - SS SW1 X T  
① ② ③ ④ ⑤ ⑥ ⑦ ⑧ ⑨ ⑩

- ① Series No.
- ② Category: Header
- ③ Connector Type: Vertical 180°
- ④ Row No.-Pin No: 08-08P
- ⑤ P: With Post
- ⑥ Key Code: A-Key A ,B-Key B ,C-Key C
- ⑦ Plastic material: SS- SPS UL94V-0
- ⑧ Plating Code: SW1-Tin Plating  
Ni: 40~120u" (1~3 $\mu$ m) ; 80~200u" (2~5 $\mu$ m)
- ⑨ Color: B-Black , G-Gray , F-Dark Grey
- ⑩ Packing: T-Tray

						GENERAL TOLERANCE				PART NO.				
						.X	±0.35			2043WV-XXPX-SSSW1XT				
						.XX	±0.25			TITLE				
						.XXX	±0.15			2.00mm Pitch Header				
						X:	±2*			ASSY Vertical 180° DIP				
						PROJECT				UNIT	SCALE	SHEET	REV	NUMBER
DATE	REV	ECN NO.	DESCRIPTION	MODIFY	APPROVAL	APPROVAL	CHECK	DRAWN	DATE	mm	1:1	1/3	X1	CD
20230703	X1	/	Key A Description modification	Joshua	Larry Yang	Jack Zhang	Larry Yang	Joshua	2023/01/06					
20230106	X0	/	Initial release	Joshua	Larry Yang									

**SMS** 东莞市思索技术股份有限公司  
Dongguan SESO Technology Co.,Ltd.

RoHS

This products can apply to the SESO Doc NO. QA-3-04-005 of Environmental&Material Management Rules

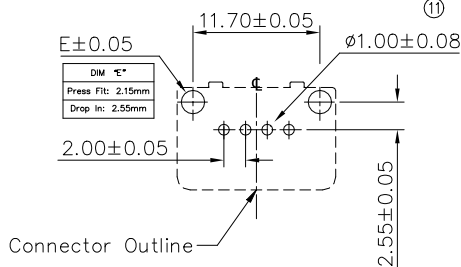
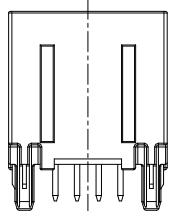
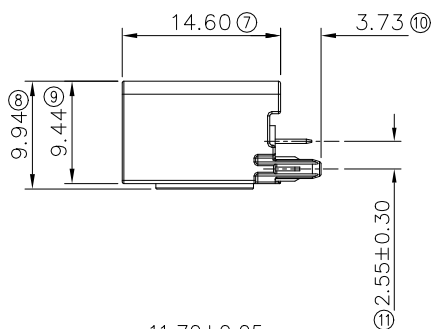
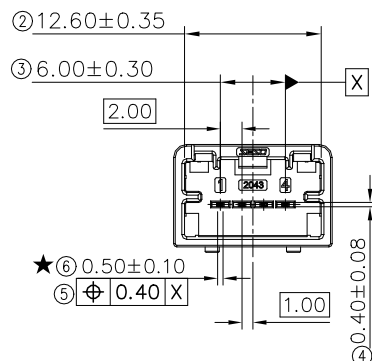
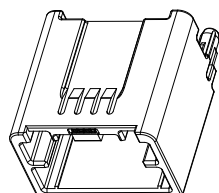
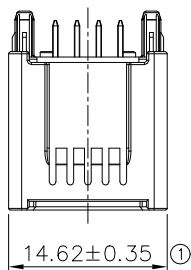

Specifications :

- Voltage rating: 50V Max. AC / DC
- Current rating: 4A Max.AC / DC
- Withstanding voltage: 1000V AC/minute
- Temperature range: -40°C~+125°C
- Insulation resistance: 100MΩ
- Contact resistance: 25mΩ Max.
- Material(Pin): Brass
- Mates With SESO Housing: 2043AM
- Symbols "★" For SPC Dimensions
- Product Specification: PS-2043-01
- Packaging: See Drawing: PK-2043WV-XXPX-SSSW1XT

2043 W V - 04 P X - SS SW1 X T  
 ① ② ③ ④ ⑤ ⑥ ⑦ ⑧ ⑨ ⑩

- ① Series No.
- ② Category: Header
- ③ Connector Type: Vertical 180°
- ④ Row No.-Pin No: 04-04P
- ⑤ P: With Post
- ⑥ Key Code: A-Key A ,B-Key B ,C-Key C , Key D
- ⑦ Plastic material: SS- SPS UL94V-0
- ⑧ Plating Code: SW1-Tin Plating  
 Ni: 40~120u" (<1~3μm) ; 80~200u" (<2~5μm)
- ⑨ Color: B-Black , G-Gray , F-Dark Grey , A-Green
- ⑩ Packing: T-Tray

APPLICABLE P.C.B LAYOUT(REF.)  
 P.C.B THICKNESS t=1.6mm

					GENERAL TOLERANCE				PART NO.					
					.X ±0.35				2043WV-XXPX-SSSW1XT					
					.XX ±0.25				TITLE					
					.XXX±0.15				2.00mm Pitch Header					
					X: ±2°				ASSY Vertical 180° DIP					
					PROJECT				UNIT					
					APPROVAL				SCALE					
					CHECK				SHEET					
					DRAWN				REV					
					DATE				NUMBER					
DATE	REV	ECN NO.	DESCRIPTION	MODIFY	APPROVAL	Jack Zhang	Larry Yang	Joshua	2023/01/06	mm	1:1	2/3	X1	CD

**SMS** 东莞市思索技术股份有限公司  
 Dongguan SESO Technology Co.,Ltd.

RoHS

This products can apply to the SESO Doc NO. QA-3-04-005 of Environmental&Material Management Rules

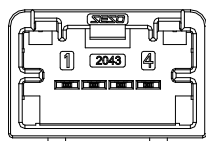

KEY A  
Color : Black

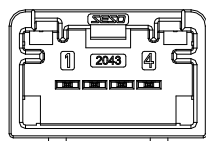

KEY B  
Color : Gray

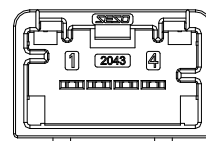

KEY C  
Color : Dark Gray

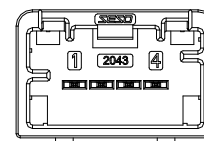

KEY D  
Color : Green

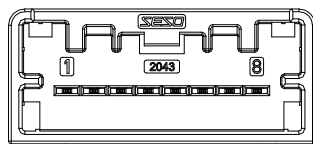

KEY A  
Color : Gray

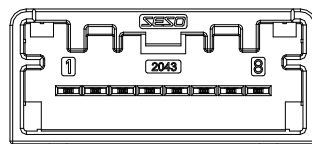

KEY B  
Color : Gray

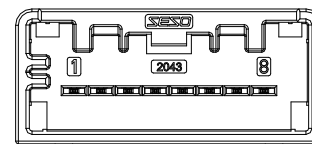

KEY C  
Color : Dark Gray

DATE	REV	ECN NO.	DESCRIPTION	MODIFY	APPROVAL	GENERAL TOLERANCE	SMS 东莞市思索技术有限公司 Dongguan SESO Technology Co.,Ltd.				PART NO. 2043WV-XXPX-SSSW1XT				
20230703	X1	/	Key A Description modification	Joshua	Larry Yang	.X ±0.35	APPROVAL	CHECK	DRAWN	DATE	TITLE 2.00mm Pitch Header ASSY Vertical 180° DIP				
20230106	X0	/	Initial release	Joshua	Larry Yang	.XX ±0.25					UNIT	SCALE	SHEET	REV	NUMBER
						.XXX±0.15									
						X: ±2*	Jack Zhang	Larry Yang	Joshua	2023/01/06					

RoHS

This products can apply to the SESO Doc NO. QA-3-04-005 of Environmental&Material Management Rules



■ Specifications :

- Voltage rating: 50V Max. AC / DC
- Current rating: 4A Max.AC / DC
- Withstanding voltage: 1000V AC/minute
- Temperature range: -40°C~+125°C
- Insulation resistance: 100MΩ
- Contact resistance: 25mΩ Max.
- Material(Pin): Brass
- Mates With SESO Housing: 2043AM
- Symbols "★" For SPC Dimensions
- Product Specification: PS-2043-01
- Packaging: See Drawing:  
PK-2043WR-XXPX-SSSW1XT

2043 W R - 08 P X - SS SW1 X I  
① ②③ ④ ⑤⑥ ⑦ ⑧ ⑨ ⑩

- ① Series No.
- ② Category: Header
- ③ Connector Type: Horizontal 90°
- ④ Row No.-Pin No: 08-08P
- ⑤ P.: With Post
- ⑥ Key Code: A-Key A ,B-Key B ,C-Key C
- ⑦ Plastic material: SS- SPS UL94V-0
- ⑧ Plating Code: SW1-Tin Plating  
Ni: 40~120u" (1~3μm) ; 80~200u" (2~5μm)
- ⑨ Color: B-Black , G-Gray , F-Dark Grey
- ⑩ Packing: T-Tray

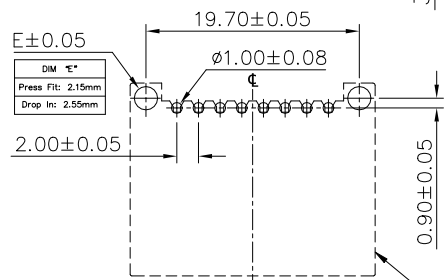
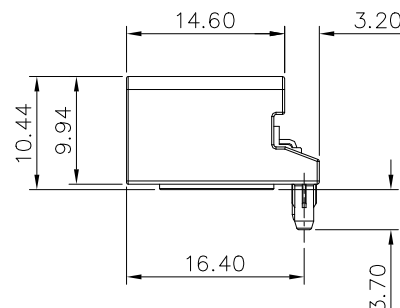
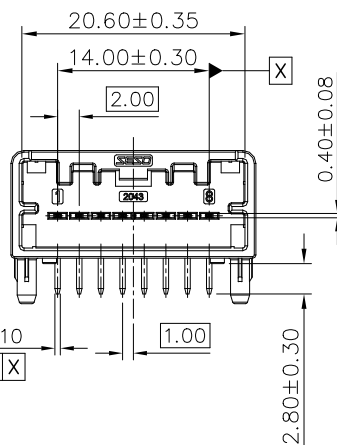
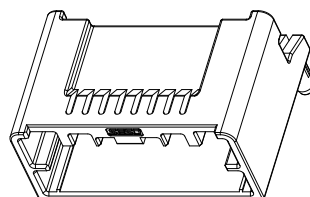
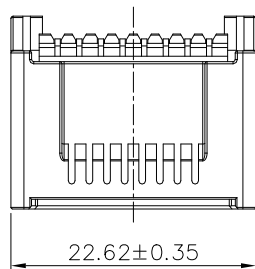

APPLICABLE P.C.B LAYOUT(REF.)  
P.C.B THICKNESS t=1.6mm

Connector Outline

DATE	REV	ECN NO.	DESCRIPTION	MODIFY	APPROVAL
20230703	X1	/	Key A Description modification	Joshua Liu	Larry Yang
20230106	X0	/	Initial release	Joshua Liu	Larry Yang

GENERAL TOLERANCE	
.X	±0.35
.XX	±0.25
.XXX	±0.15
X.*	±2*
PROJECT	

**SMS** 东莞市思索技术股份有限公司  
Dongguan SESO Technology Co.,Ltd.

APPROVAL	CHECK	DRAWN	DATE
Jack Zhang	Larry Yang	Joshua Liu	2023/01/06

PART NO. 2043WR-XXPX-SSSW1XT				
TITLE 2.00mm Pitch Header ASSY Horizontal 90° DIP				
UNIT	SCALE	SHEET	REV	NUMBER
mm	1:1	1/3	X1	CD



RoHS

This products can apply to the SESO Doc NO. QA-3-04-005 of Environmental&Material Management Rules



Specifications :

- Voltage rating: 50V Max. AC / DC
- Current rating: 4A Max.AC / DC
- Withstanding voltage: 1000V AC/minute
- Temperature range: -40°C~+125°C
- Insulation resistance: 100MΩ
- Contact resistance: 25mΩ Max.
- Material(Pin): Brass
- Mates With SESO Housing: 2043AM
- Symbols "★"For SPC Dimensions
- Product Specification: PS-2043-01
- Packaging: See Drawing:  
PK-2043WR-XXPX-SSSW1XT

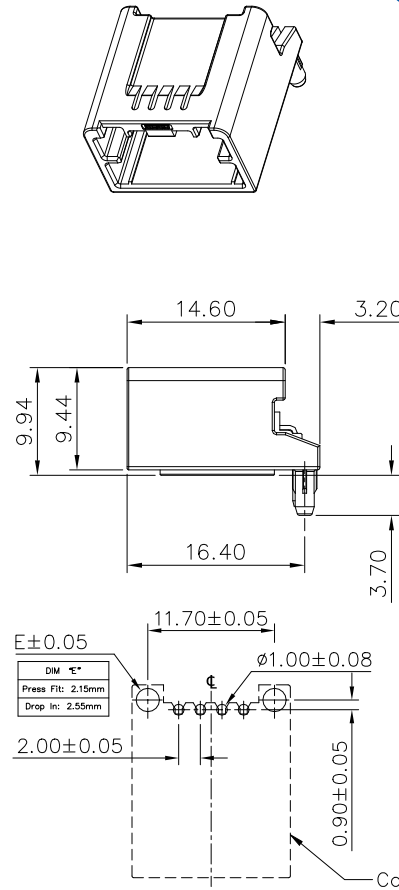
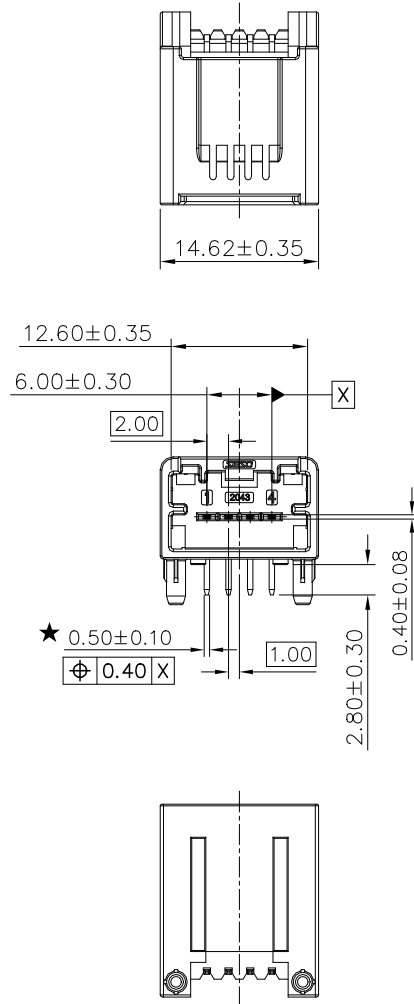

APPLICABLE P.C.B LAYOUT(REF.)

P.C.B THICKNESS t=1.6mm

2043 W R - 04 P X - SS SW1 X T  
① ② ③ ④ ⑤ ⑥ ⑦ ⑧ ⑨ ⑩

- ① Series No.
- ② Category: Header
- ③ Connector Type: Horizontal 90°
- ④ Row No.-Pin No: 04-04P
- ⑤ P.: With Post
- ⑥ Key Code: A-Key A ,B-Key B ,C-Key C , Key D
- ⑦ Plastic material: SS- SPS UL94V-0
- ⑧ Plating Code: SW1-Tin Plating  
Ni: 40~120u" (1~3μm) ; 80~200u" (2~5μm)
- ⑨ Color: B-Black, G-Gray, F-Dark Grey, A-Green
- ⑩ Packing: T-Tray

						GENERAL TOLERANCE				PART NO.								
						.X ±0.35				2043WR-XXPX-SSSW1XT								
						.XX ±0.25				TITLE 2.00mm Pitch Header								
						.XXX±0.15				ASSY Horizontal 90° DIP								
						X: ±2*				APPROVAL	CHECK	DRAWN	DATE					
						PROJECT				Jack Zhang	Larry Yang	Joshua Liu	2023/01/06	UNIT	SCALE	SHEET	REV	NUMBER
DATE	REV	ECN NO.	DESCRIPTION	MODIFY	APPROVAL					mm	1:1	2/3	X1	CD				

**SMS** 东莞市思索技术股份有限公司  
Dongguan SESO Technology Co.,Ltd.

RoHS

This products can apply to the SESO Doc NO. QA-3-04-005 of Environmental&Material Management Rules

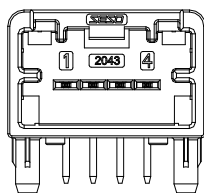

KEY A  
Color : Black

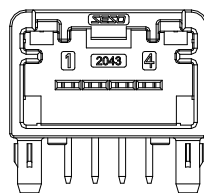

KEY B  
Color : Gray

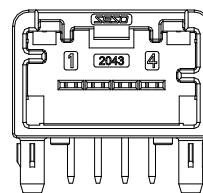

KEY C  
Color : Dark Gray

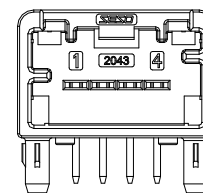

KEY D  
Color : Green

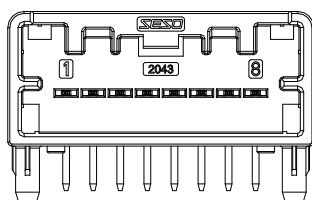

KEY A  
Color : Gray

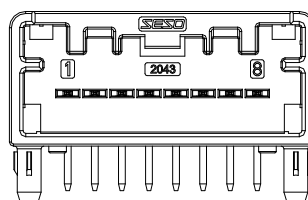

KEY B  
Color : Gray

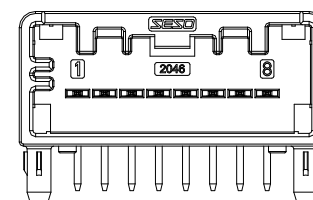

KEY C  
Color : Dark Gray

						GENERAL TOLERANCE				PART NO.					
						.X ±0.35				2043WR-XXPX-SSSW1XT					
						.XX ±0.25				TITLE 2.00mm Pitch Header					
						.XXX±0.15				ASSY Horizontal 90° DIP					
						X: ±2*				APPROVAL	CHECK	DRAWN	DATE		
						PROJECT				Jack Zhang	Larry Yang	Joshua Liu	2023/01/06		
DATE	REV	ECN NO.	DESCRIPTION	MODIFY	APPROVAL	UNIT	SCALE	SHEET	REV	NUMBER					
						mm	1:1	3/3	X1	CD					

**SMS** 东莞市思索技术股份有限公司  
Dongguan SESO Technology Co.,Ltd.

RoHS

This products can apply to the SESO Doc NO. QA-3-04-005 of Environmental&Material Management Rules

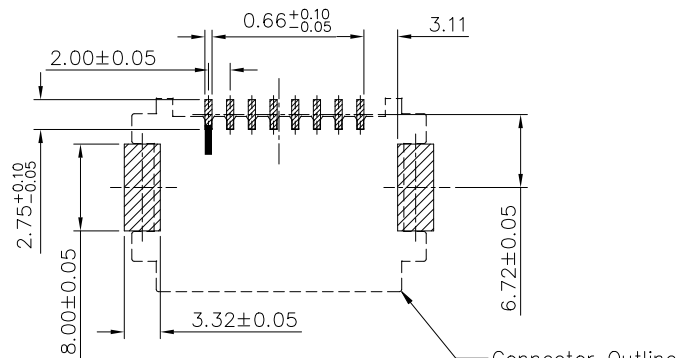
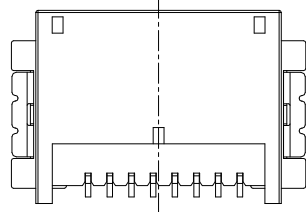
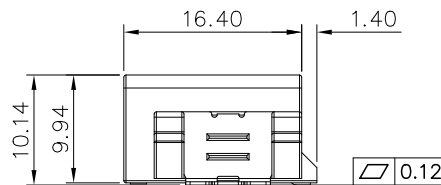
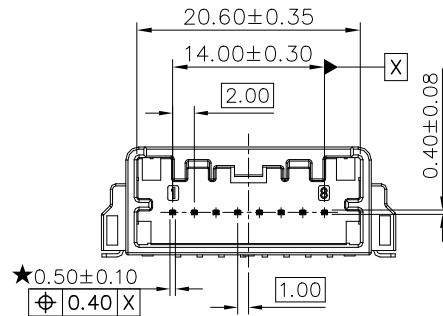
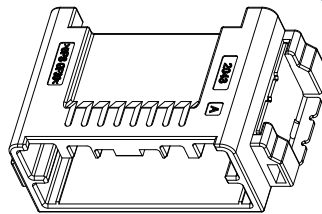
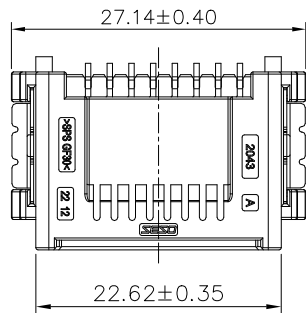

APPLICABLE P.C.B LAYOUT(REF.)  
P.C.B THICKNESS t=1.6mm

■ Specifications :

- Voltage rating: 50V Max. AC / DC
- Current rating: 4A Max.AC / DC
- Withstanding voltage: 1000V AC/minute
- Temperature range: -40°C~+125°C
- Insulation resistance: 100MΩ
- Contact resistance: 25mΩ Max.
- Material(Pin): Brass
- Mates With SESO Housing: 2043AM
- Symbols "★" For SPC Dimensions
- Product Specification: PS-2043-01
- Packaging: See Drawing:  
PK-2043WRS-XXX-SSSW1XR

2043 W R S - 08 X - SS SW1 X R  
① ②③④ ⑤ ⑥ ⑦ ⑧ ⑨ ⑩

- ① Series No.
- ② Category: Header
- ③ Connector Type: Horizontal 90°
- ④ S-SMT Type
- ⑤ Row No.-Pin No: 08-08P
- ⑥ Key Code: A-Key A ,B-Key B ,C-Key C
- ⑦ Plastic material: SS- SPS UL94V-0
- ⑧ Plating Code: SW1-Tin Plating  
Ni: 40~120u" (1~3μm) ; 80~200u" (2~5μm)
- ⑨ Color: B-Black , G-Gray , F-Dark Grey
- ⑩ Packing: R-Reel

						GENERAL TOLERANCE				PART NO. 2043WRS-XXX-SSSW1XR							
						.X ±0.35				APPROVAL							
						.XX ±0.25											
						.XXX±0.15											
						X.* ±2*				CHECK							
						PROJECT				DRAWN							
						APPROVAL				DATE							
						Jack Zhang				Larry Yang							
						Joshua Liu				2023/01/06							
DATE			REV			ECN NO.			DESCRIPTION			MODIFY			APPROVAL		
UNIT			SCALE			SHEET			REV			NUMBER					
mm			1:1			1/4			X1			CD					

**SMS** 东莞市思索技术股份有限公司  
Dongguan SESO Technology Co.,Ltd.

TITLE 2.00mm Pitch Header  
ASSY Horizontal 90° SMT

RoHS

This products can apply to the SESO Doc NO. QA-3-04-005 of Environmental&Material Management Rules

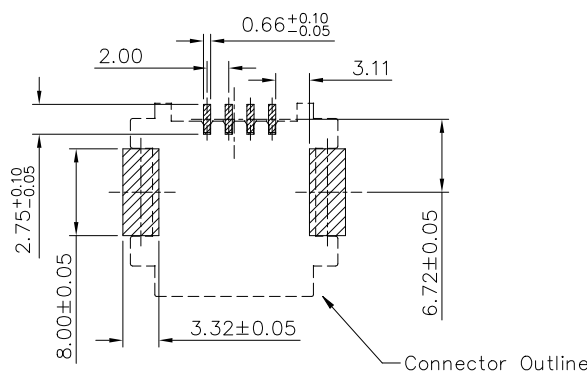
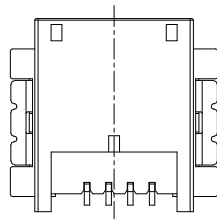
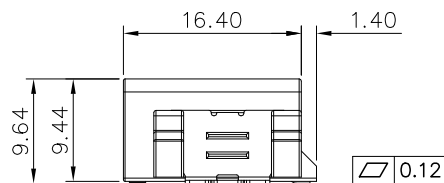
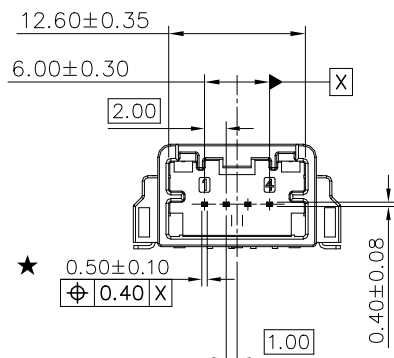
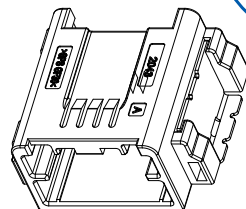
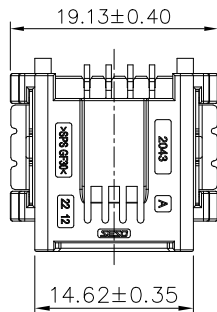

APPLICABLE P.C.B LAYOUT(REF.)  
P.C.B THICKNESS t=1.6mm

■ Specifications :

- Voltage rating: 50V Max. AC / DC
- Current rating: 4A Max.AC / DC
- Withstanding voltage: 1000V AC/minute
- Temperature range: -40°C~+125°C
- Insulation resistance: 100MΩ
- Contact resistance: 25mΩ Max.
- Material(Pin): Brass
- Mates With SESO Housing: 2043AM
- Symbols "★"For SPC Dimensions
- Product Specification: PS-2043-01
- Packaging: See Drawing:  
PK-2043WRS-XXX-SSSW1XR

2043 W R S - 04 X- SS SW1 X R  
① ②③④ ⑤⑥ ⑦ ⑧ ⑨⑩

- ① Series No.
- ② Category: Header
- ③ Connector Type: Horizontal 90°
- ④ S-SMT Type
- ⑤ Row No.-Pin No: 04-04P
- ⑥ Key Code: A-Key A ,B-Key B ,C-Key C , Key D
- ⑦ Plastic material: SS- SPS UL94V-0
- ⑧ Plating Code: SW1-Tin Plating  
Ni: 40~120u" (1~3μm) ; 80~200u" (2~5μm)
- ⑨ Color: B-Black , G-Gray , F-Dark Grey , A-Green
- ⑩ Packing: R-Reel

A

DATE	REV	ECN NO.	DESCRIPTION	MODIFY	APPROVAL
20230703	X1	/	Key A Description modification	Joshua Liu	Larry Yang
20230106	X0	/	Initial release	Joshua Liu	Larry Yang

GENERAL TOLERANCE	
.X	±0.35
.XX	±0.25
.XXX	±0.15
X.*	±2*
PROJECT	

**SMS** 东莞市思索技术股份有限公司  
Dongguan SESO Technology Co.,Ltd.

APPROVAL	CHECK	DRAWN	DATE
Jack Zhang	Larry Yang	Joshua Liu	2023/01/06

PART NO.				
2043WRS-XXX-SSSW1XR				
TITLE				
2.00mm Pitch Header ASSY Horizontal 90° SMT				
UNIT	SCALE	SHEET	REV	NUMBER
mm	1:1	2/4	X1	CD

1 2 3 4 5 6 7 8

RoHS

This products can apply to the SESO Doc NO. QA-3-04-005 of Environmental&Material Management Rules

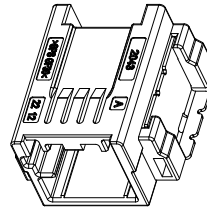
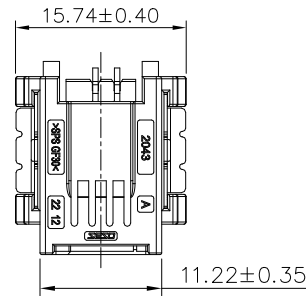

■ Specifications :

- Voltage rating: 50V Max. AC / DC
- Current rating: 4A Max.AC / DC
- Withstanding voltage: 1000V AC/minute
- Temperature range: -40°C~+125°C
- Insulation resistance: 100MΩ
- Contact resistance: 25mΩ Max.
- Material(Pin): Brass
- Mates With SESO Housing: 2043AM
- Symbols "★"For SPC Dimensions
- Product Specification: PS-2043-01
- Packaging: See Drawing: PK-2043WRS-XXX-SSSW1XR

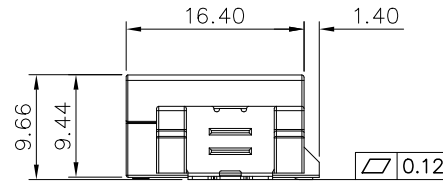
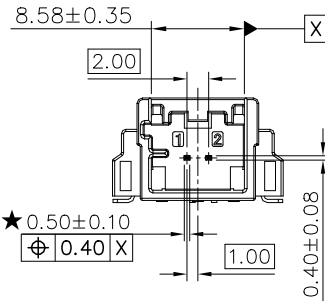

2043 W R S - 02 X- SS SW1 X R  
 ① ②③④ ⑤ ⑥ ⑦ ⑧ ⑨ ⑩

- ① Series No.
- ② Category: Header
- ③ Connector Type: Horizontal 90°
- ④ S-SMT Type
- ⑤ Row No.-Pin No: 02-02P
- ⑥ Key Code: A-Key A ,B-Key B ,C-Key C , Key D
- ⑦ Plastic material: SS- SPS UL94V-0
- ⑧ Plating Code: SW1-Tin Plating  
 Ni: 40~120u" (1~3μm) ; 80~200u" (2~5μm)
- ⑨ Color: B-Black , G-Gray , F-Dark Grey , A-Green
- ⑩ Packing: R-Reel

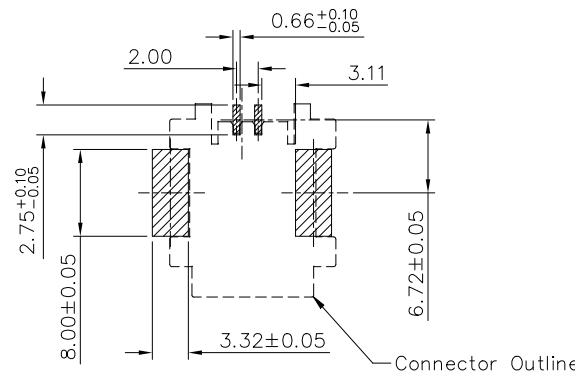

APPLICABLE P.C.B LAYOUT(REF.)  
 P.C.B THICKNESS t=1.6mm

					GENERAL TOLERANCE				PART NO. 2043WRS-XXX-SSSW1XR				
					.X ±0.35				TITLE 2.00mm Pitch Header ASSY Horizontal 90° SMT				
					.XX ±0.25				APPROVAL				
					.XXX±0.15				CHECK				
					X: ±2°				DRAWN				
					PROJECT				DATE				
					APPROVAL				UNIT				
					DATE				SCALE				
					PROJECT				SHEET				
					PROJECT				REV				
					PROJECT				NUMBER				
					PROJECT				mm				
					PROJECT				1:1				
					PROJECT				3/4				
					PROJECT				X1				
					PROJECT				CD				

**SMS** 东莞市思索技术股份有限公司  
 Dongguan SESO Technology Co.,Ltd.

Jack Zhang   Larry Yang   Joshua Liu   2023/01/06

RoHS

This products can apply to the SESO Doc NO. QA-3-04-005 of Environmental&Material Management Rules

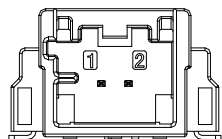

KEY A  
Color : Black

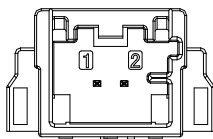

KEY B  
Color : Gray

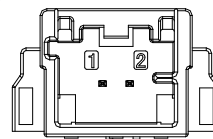

KEY C  
Color : Dark Gray

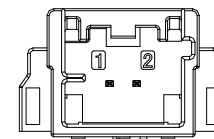

KEY D  
Color : Green

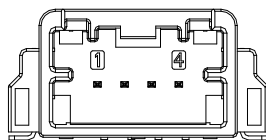

KEY A  
Color : Black

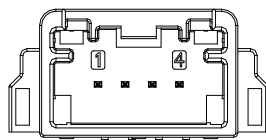

KEY B  
Color : Gray

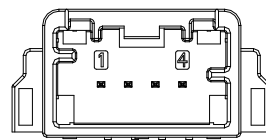

KEY C  
Color : Dark Gray

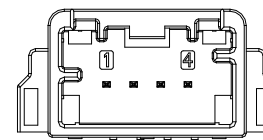

KEY D  
Color : Green

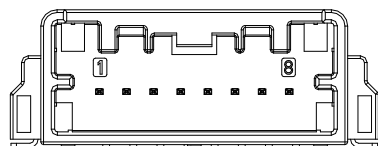

KEY A  
Color : Gray

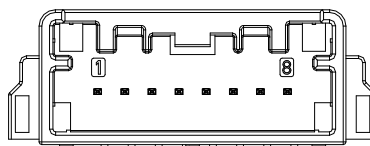

KEY B  
Color : Gray

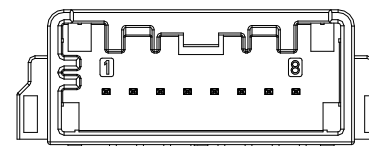

KEY C  
Color : Dark Gray

A

20230703	X1	/	Key A Description modification	Joshua Liu	Larry Yang
20230106	X0	/	Initial release	Joshua Liu	Larry Yang
DATE	REV	ECN NO.	DESCRIPTION	MODIFY	APPROVAL

GENERAL TOLERANCE
.X ±0.35
.XX ±0.25
.XXX±0.15
X* ±2*
PROJECT

**SMS** 东莞市思索技术股份有限公司  
Dongguan SESO Technology Co.,Ltd.

APPROVAL	CHECK	DRAWN	DATE
Jack Zhang	Larry Yang	Joshua Liu	2023/01/06

PART NO. 2043WRS-XXX-SSSW1XR				
TITLE 2.00mm Pitch Header ASSY Horizontal 90° SMT				
UNIT	SCALE	SHEET	REV	NUMBER
mm	1:1	4/4	X1	CD

1

2

3

4

5

6

7

8

A