

RoHS

This products can apply to the SESO Doc NO. QA-3-04-005 of Environmental&Material Management Rules

Part NO.

Dimensions/mm

Part NO.	A	B	C	D
	2022H-02A-PTNC	2.00	4.70	6.10
2022H-03A-PTNC	4.00	6.70	8.10	10.00
2022H-04A-PTNC	6.00	8.70	10.10	12.00
2022H-05A-PTNC	8.00	10.70	12.10	14.00
2022H-06A-PTNC	10.00	12.70	14.10	16.00
2022H-07A-PTNC	12.00	14.70	16.10	18.00
2022H-08A-PTNC	14.00	16.70	18.10	20.00
2022H-09A-PTNC	16.00	18.70	20.10	22.00
2022H-10A-PTNC	18.00	20.70	22.10	24.00
2022H-11A-PTNC	20.00	22.70	24.10	26.00
2022H-12A-PTNC	22.00	24.70	26.10	28.00
2022H-13A-PTNC	24.00	26.70	28.10	30.00
2022H-14A-PTNC	26.00	28.70	30.10	32.00
2022H-15A-PTNC	28.00	30.70	32.10	34.00

Specifications :

- Voltage rating: 125V Max. AC/DC
- Withstanding voltage: 1000V AC/minute
- Temperature range: -40°C~+125°C
- Insulation resistance: 100MΩ min./500V DC/Minute
- Mates With SESO Terminal: 2022T-XXX-A
- Mates With SESO TPA: C2022-XXA
- Mates With SESO Wafer: 2008WX-XX
- Symbols for SPC dimensions: "★"
- Product Specification: PS-2022-03
- Packaging Drawing: PK-2022H-XXA-PTNC

2022 H - XX A - PT NC
 ① ② ③ ④ ⑤ ⑥

- ① Series No.: 2022
- ② Connector Type: H-Housing
- ③ Row No.-Pin No: XX-Single Row 02~15Pin
- ④ Special No.: A-A Type
- ⑤ Plastic material: PT-PBT UL94V-0
- ⑥ Color: NC-Natural

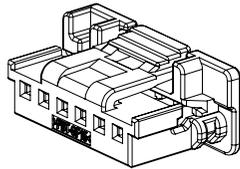
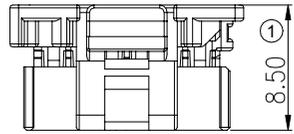

A VIEW

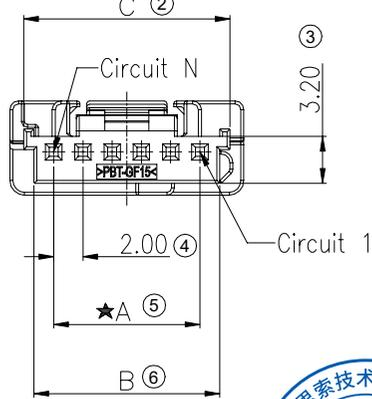

B VIEW

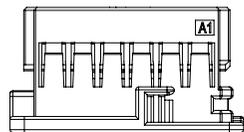
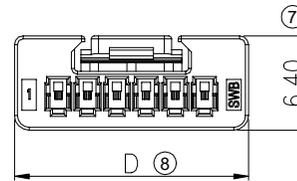
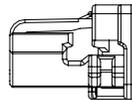

A VIEW

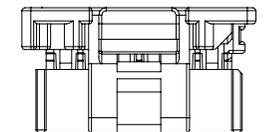
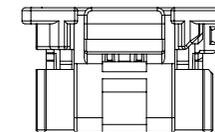
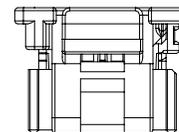
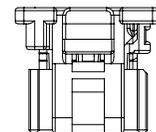
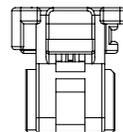

(4.70)

(4.90)

(6.90)

(6.90)

(6.90)

B VIEW

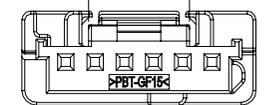
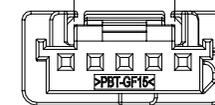
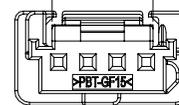
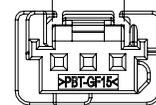
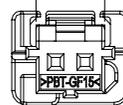

2P

3P

4P

5P

6~15P

DATE	REV	ECN NO.	DESCRIPTION	MODIFY	APPROVAL
20230828	A1	/	Update Drawing Frame	Zhou Jiasheng	John Yang
20210701	A0	/	Initial release	Cai Zhao	John Yang

GENERAL TOLERANCE	
.X	±0.35
.XX	±0.25
.XXX	±0.15
X.°	±2°
PROJECT	

SMS 东莞市思索技术股份有限公司
 Dongguan SESO Technology Co.,Ltd.

APPROVAL	CHECK	DRAWN	DATE
Kevin	John Yang	Cai Zhao	2021/07/01

PART NO.				
2022H-XXA-PTNC				
TITLE				
2.00 WTB CONN. Housing				
UNIT	SCALE	SHEET	REV	NUMBER
mm	1:1	1/1	A1	A-000

RoHS

This products can apply to the SESO Doc NO. QA-3-04-005 of Environmental&Material Management Rules

Specifications:

- Current Rating:3A AC/DC(0.35mm² Wire)
- Temperature Range:
High conductivity copper:-40°C~+125°C
Phosphor Bronze:-40°C~+105°C
- Contact Resistance:<10mΩ(Initial)
<20mΩ(After Testing)
- Mates With SESO Housing:2022H-XXA
- Packaging Drawing:PK-2022T-XXX-A
- Product Specification:PS-2022-03
- Symbols for SPC Dimensions:"★"

Note: 1.Material Mark:

- "" Represent High conductivity copper
- "" Represent Phosphor Bronze

2022 ① - ② ③ ④ ⑤ - ⑥

- ① Series No.:2022
- ② Category:T-Terminal
- ③ Material:H-High conductivity copper
P-Phosphor Bronze
- ④ Plating Code: Y2-40~120u"(1~3um) TIN
SN1-Underplate Ni 40~120u"(1~3um) ;
Top Plating Sn 80~200u"(2~5um)
V1-Underplate Ni 40~120u"(1~3um) ;
All Gold-Plated 1u" Min(0.0254um)
G1 -Underplate Ni 40~120u"(1~3um) ;
Area 1 Plating Au 1u" Min(0.0254um)
- ⑤ Plating Process: B-Stamping After Plating
Blank-Stamping Before Plating
- ⑥ Special No.: A-A Type

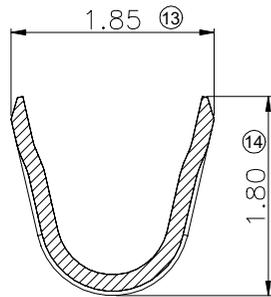
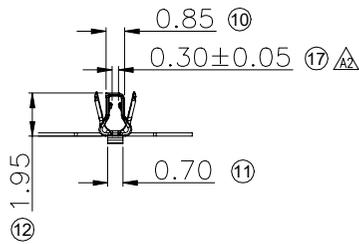
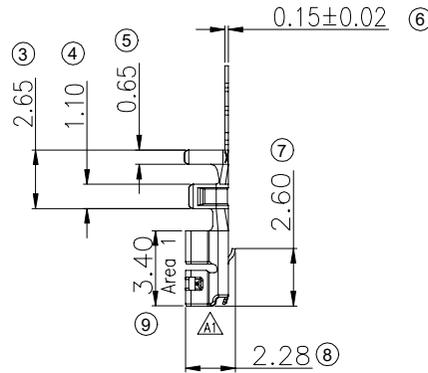
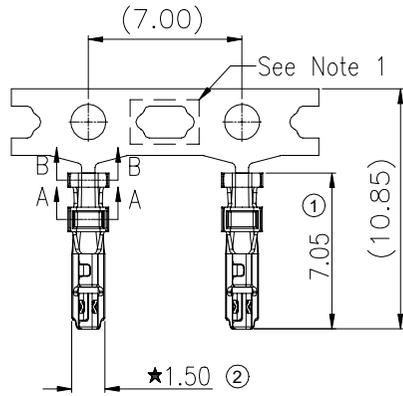

SECTION A-A
SCALE 15:1

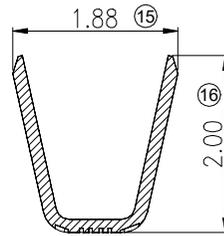

SECTION B-B
SCALE 12:1

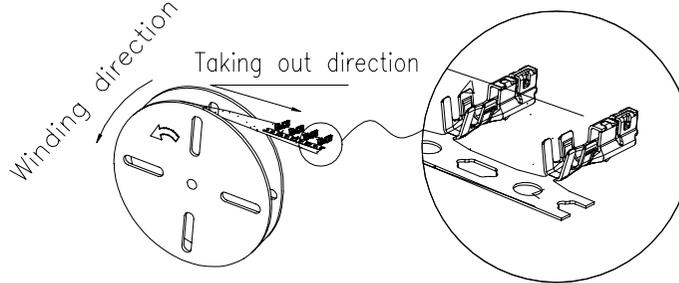
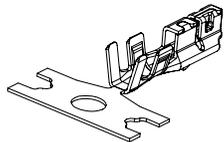

2022T-PG1-A	AWG#22 (0.35mm ²)	ø1.4mm Max
2022T-PV1-A		
2022T-PSN1-A		
2022T-HY2B-A		

Part NO.	Wire Range	Insulation O.D.
----------	------------	-----------------

20230828	A3	/	Update Drawing Frame	Zhou Jiasheng	Larry Yang
20220815	A2	/	Increase the terminal clip size	Wangcheng	Larry Yang
20220329	A1	EN20220413001	Modify the terminal header structure	Wangcheng	Larry Yang
DATE	REV	ECN NO.	DESCRIPTION	MODIFY	APPROVAL

GENERAL TOLERANCE				 东莞市思索技术股份有限公司 Dongguan SESO Technology Co.,Ltd.	APPROVAL	CHECK	DRAWN	DATE
.X	±0.35							
.XX	±0.25							
.XXX	±0.15							
X.°	±2°	PROJECT		John Zhang	John Yang	Cai Zhao	2021/07/03	

PART NO.				
2022T-XXX-A				
TITLE				
2.00 WTB crimp terminal				
UNIT	SCALE	SHEET	REV	NUMBER
mm	1:1	1/1	A3	A-000

RoHS

This products can apply to the SESO Doc NO. QA-3-04-005 of Environmental&Material Management Rules

■ Specifications :

- Temperature Range:-40°C~+125°C
- Mates With SESO Housing:2022H-XXA
- Packaging Drawing:PK-C2022-XXA-PTGY
- Symbols for SPC dimensions:" ★ "

C 2022-XX A X-PT GY

① ② ③ ④ ⑤ ⑥ ⑦

- ① Connector Type: C-TPA
- ② Series No.: 2022
- ③ Row No.-Pin No: XX-Single Row 02~15Pin
- ④ Special No.: A-A Type
- ⑤ Special No.: A-Without Logo
Blank-With "SWB" Logo
- ⑥ Plastic Material: PT-PBT-GF UL94V-0
- ⑦ Color: GY-Gray

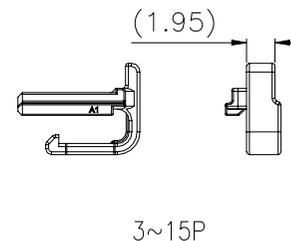
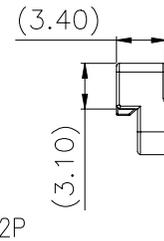
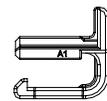
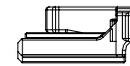
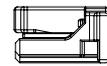
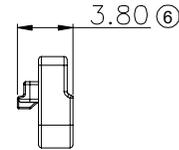
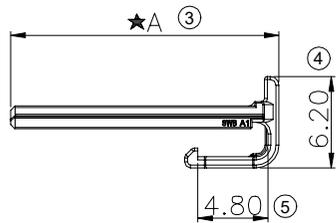
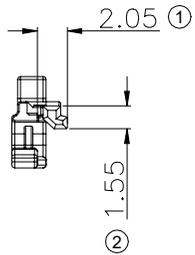

Dimensions/mm	
Part NO.	A
C2022-02A-PTGY	6.35
C2022-03A-PTGY	8.35
C2022-04A-PTGY	10.35
C2022-05A-PTGY	12.35
C2022-06A-PTGY	14.35
C2022-07A-PTGY	16.35
C2022-08A-PTGY	18.35
C2022-09A-PTGY	20.35
C2022-10A-PTGY	22.35
C2022-11A-PTGY	24.35
C2022-12A-PTGY	26.35
C2022-13A-PTGY	28.35
C2022-14A-PTGY	30.35
C2022-15A-PTGY	32.35

DATE	REV	ECN NO.	DESCRIPTION	MODIFY	APPROVAL
20230828	A2	/	Update Drawing Frame	Zhou Jiasheng	Larry Yang
20221028	A1	/	Added no LOGO material number	Cai Zhao	John Yang
20210702	A0	/	Initial release	Cai Zhao	John Yang

GENERAL TOLERANCE	
.X	±0.35
.XX	±0.25
.XXX	±0.15
X.°	±2°
PROJECT	

SMS 东莞市思索技术股份有限公司
Dongguan SESO Technology Co.,Ltd.

APPROVAL	CHECK	DRAWN	DATE
Kevin	John Yang	Cai Zhao	2021/07/02

PART NO.				
C2022-XXAX-PTGY				
TITLE				
2.00 WTB CONN. TPA				
UNIT	SCALE	SHEET	REV	NUMBER
mm	1:1	1/1	A2	A-000

RoHS

This products can apply to the SESO Doc NO. QA-3-04-005 of Environmental&Material Management Rules

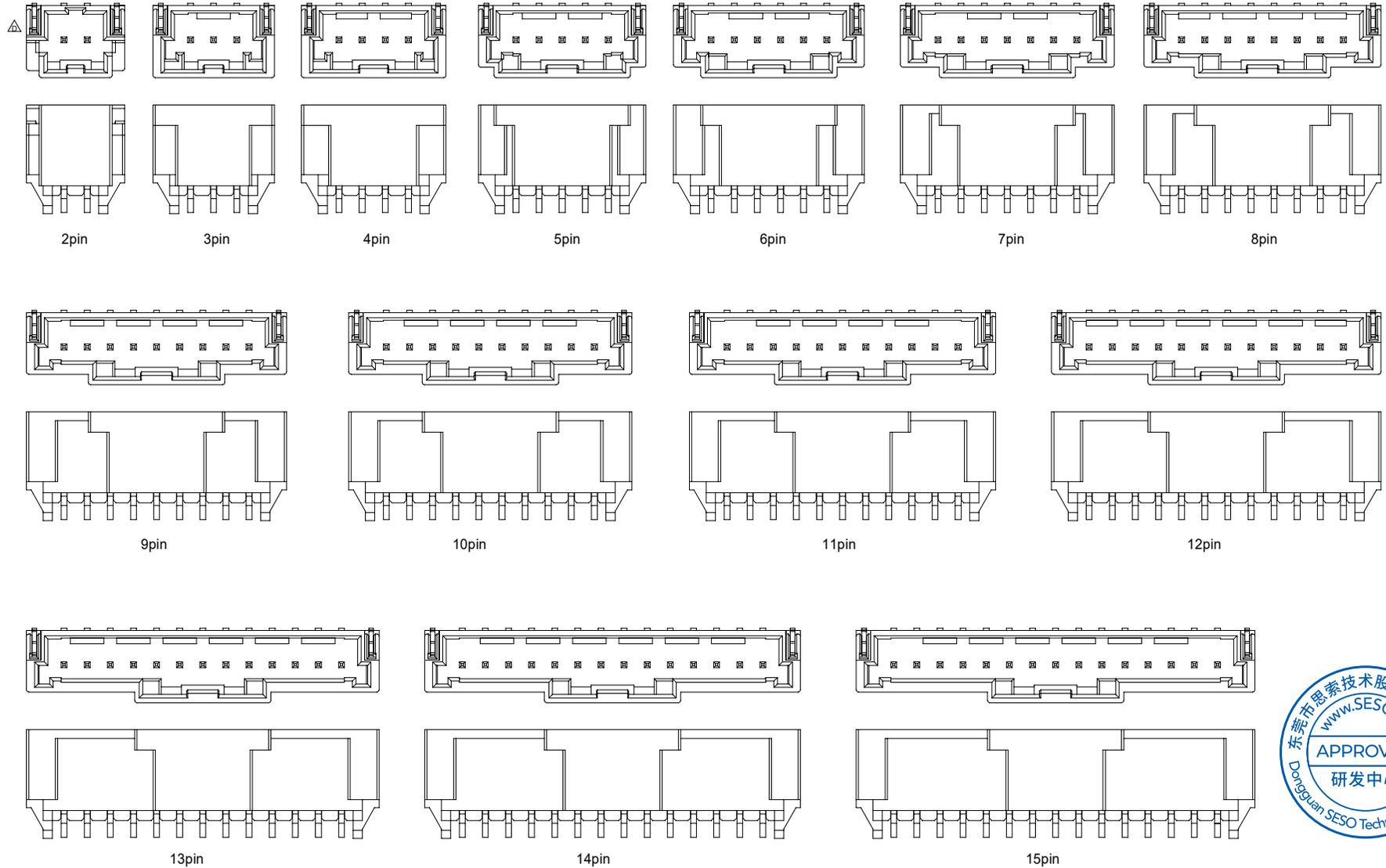

						GENERAL TOLERANCE				PART NO.				
						.X ±0.30				2008WRS-1xXX-XXXB05RRXXXQ				
						.XX ±0.20				TITLE				
						.XXX±0.10				Pitch 2.00 mm 90° SMT Wafer Connectors				
						X.' ±2'				APPROVAL				
						PROJECT				Robing				
						APPROVAL				Joshua				
						DATE				Alan qin				
						DATE				2018/10/16				
						UNIT				mm				
						SCALE				1:1				
						SHEET				2/2				
						REV				E1				
						NUMBER				A-000				

SMS 东莞市思索技术股份有限公司
Dongguan SESO Technology Co.,Ltd.

RoHS

This products can apply to the SESO Doc NO. QA-3-04-005 of Environmental&Material Management Rules

- Specifications :
- Voltage rating: 125V AC / DC
 - Current rating: 3A AC / DC
 - Withstanding voltage: 500V AC/minute
 - Temperature range: -40°C~+105°C
 - Insulation resistance: ≥1000MΩ
 - Contact resistance: ≤10mΩ
 - After environmental testing: ≤20mΩ
 - Material(Pin): Brass
 - Mates With SESO Housing: 2008H
 - "★" Critical dimension

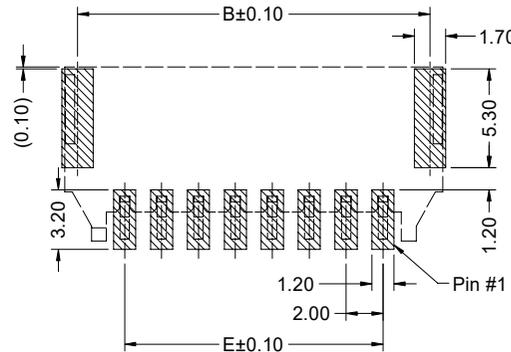
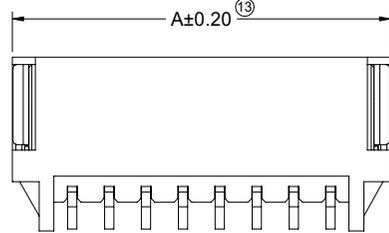
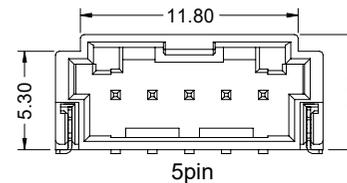
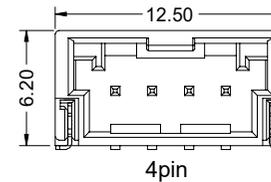
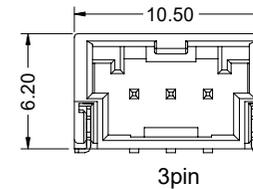
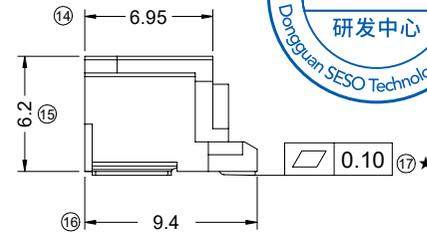
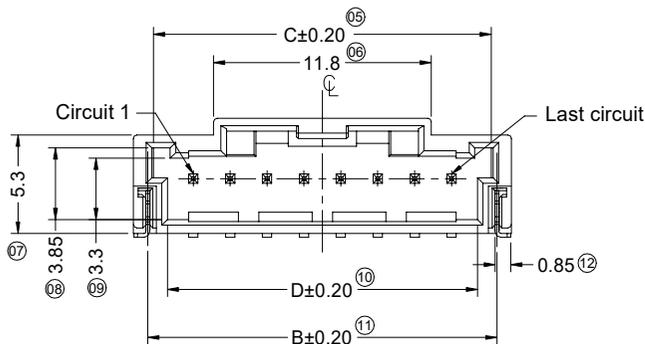
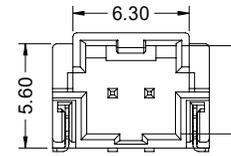
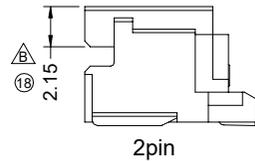
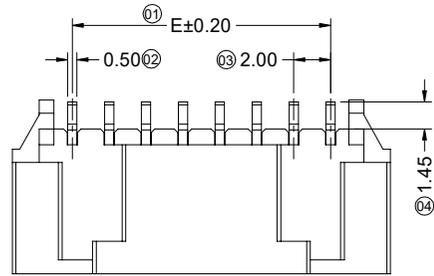

2008 W R S - XX - XX XXX X XX
① ② ③ ④ ⑤ ⑥ ⑦ ⑧ ⑨

- ① Series No.
- ② Category: W-wafer
- ③ Connector Type: R-Right Angle 90°
- ④ Mounting Type: S-SMT
- ⑤ Row No.-Pin No Per Row: XX-Single Row XXPin
- ⑥ Plastic material: 9T- PA9T UL94V-0; LP- LCP UL94V-0
- ⑦ Plating Code: SW1-Matte Tin GW01-Contact Gold Flash
- ⑧ Color: N-Natural; B-Black; R-Red; L-Blue
- ⑨ Packing: R- Reel (Heatsealing) R1- Reel (Coldsealing)

Poles	Dimensions (mm)				
	A	B	C	D	E
02	8.50	6.93	6.30	4.80	2.00
03	10.50	8.93	8.30	6.80	4.00
04	12.50	10.93	10.30	8.80	6.00
05	14.50	12.93	12.30	10.80	8.00
06	16.50	14.93	14.30	12.80	10.00
07	18.50	16.93	16.30	14.80	12.00
08	20.50	18.93	18.30	16.80	14.00
09	22.50	20.93	20.30	18.80	16.00
10	24.50	22.93	22.30	20.80	18.00
11	26.50	24.93	24.30	22.80	20.00
12	28.50	26.93	26.30	24.80	22.00
13	30.50	28.93	28.30	26.80	24.00
14	32.50	30.93	30.30	28.80	26.00
15	34.50	32.93	32.30	30.80	28.00

GENERAL TOLERANCE					PART NO.			
.X ±0.30					2008WRS-XX-XXXXXXXX			
.XX ±0.20					TITLE			
.XXX ±0.10					Pitch 2.00 mm 90° SMT Wafer Connectors			
X.° ±2°					APPROVAL	CHECK	DRAWN	DATE
DATE	REV	ECN NO.	DESCRIPTION	MODIFY	Larry Yang	Larry Yang	Xue	2022.10.14
PROJECT					UNIT SCALE SHEET REV NUMBER			
mm 1:1 1/2 A0 A-000								

SMS 东莞市思索技术股份有限公司
Dongguan SESO Technology Co.,Ltd.

RoHS

This products can apply to the SESO Doc NO. QA-3-04-005 of Environmental&Material Management Rules

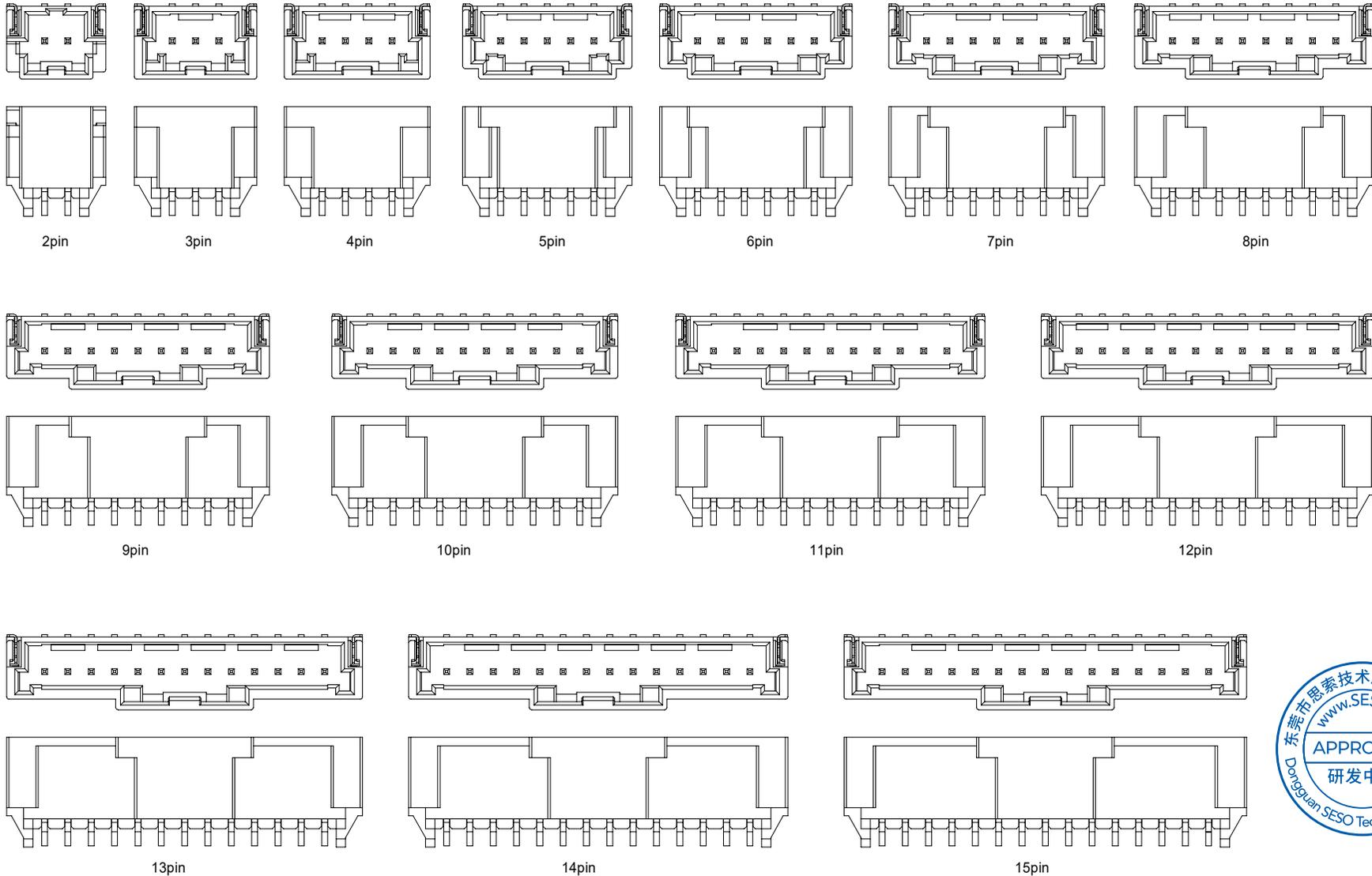

					GENERAL TOLERANCE .X ±0.30 .XX ±0.20 .XXX ±0.10 X.° ±2°				SMS 东莞市思索技术股份有限公司 Dongguan SESO Technology Co.,Ltd.				PART NO. 2008WRS-XX-XXXXXXXXX												
					APPROVAL Larry Yang				CHECK Larry Yang				DRAWN Xue				DATE 2022.10.14				TITLE Pitch 2.00 mm 90° SMT Wafer Connectors				
DATE	REV	ECN NO.	DESCRIPTION	MODIFY	APPROVAL	PROJECT		UNIT		SCALE	SHEET	REV	NUMBER												
								mm		1:1	2/2	A0	A-000												

RoHS

This products can apply to the SESO Doc NO. QA-3-04-005 of Environmental&Material Management Rules

- Specifications :
- Voltage rating: 125V AC / DC
 - Current rating: 3A AC / DC
 - Withstanding voltage: 500V AC/minute
 - Temperature range: -40°C~+125°C
 - Insulation resistance: ≥1000MΩ
 - Contact resistance: ≤10mΩ
 - After environmental testing: ≤20mΩ
 - Material(Pin): Brass
 - Mates With SESO Housing: 2008H
 - "★" Critical dimension



2008 W V S - 1 x XX - XX X B XX X R XXX Q
 ① ② ③ ④ ⑤ ⑥ ⑦ ⑧ ⑨ ⑩ ⑪ ⑫ ⑬

- ① Series No.
- ② Category: W-wafer
- ③ Connector Type: V-Straight 180°
- ④ Mounting Type: S-SMT
- ⑤ Row No.-Pin No: 1xXX-Single Row 1xXXPin
- ⑥ Plastic material: 9T- PA9T 94V-0; LP- LCP 94V-0
- ⑦ Color: N-Natural; B-Black; R-Red; L-Blue
- ⑧ Metal material: B-Brass
- ⑨ Plating Code: 05-Matte Tin
30-Contact Area: Gold flash
Solder Area: Matte Tin
- ⑩ Packing: R-Reel, Without Mylar
- ⑪ RoHS/HF: R-RoHS H-Halogen-Free
- ⑫ Sequence Number: 002-Coldsealing ; 02C-Heatsealing
- ⑬ Special code :Q-Automotive Connectors

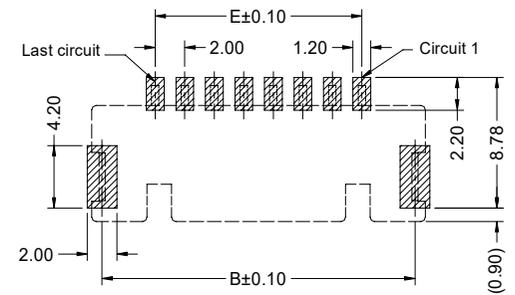
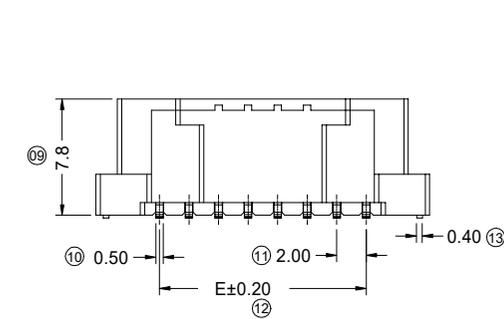
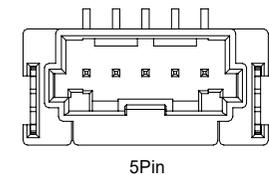
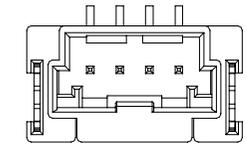
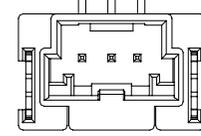
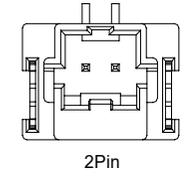
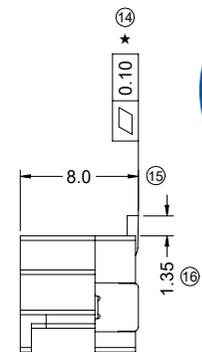
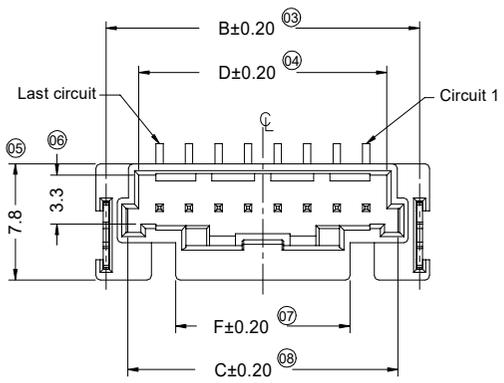
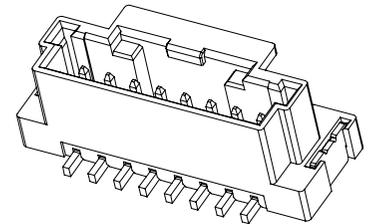
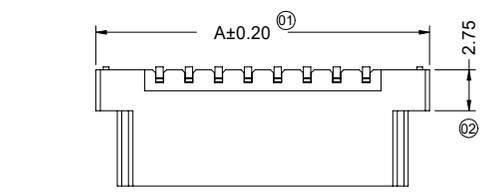

RECOMMENDED P.C.B LAYOUT (TOLERANCE:±0.05)

Poles	Dimensions (mm)					
	A	B	C	D	E	F
02	10.60	9.23	6.30	4.80	2.00	6.30
03	12.60	11.23	8.30	6.80	4.00	5.80
04	14.60	13.23	10.30	8.80	6.00	7.80
05	16.60	15.23	12.30	10.80	8.00	9.80
06	18.60	17.23	14.30	12.80	10.00	11.80
07	20.60	19.23	16.30	14.80	12.00	11.80
08	22.60	21.23	18.30	16.80	14.00	11.80
09	24.60	23.23	20.30	18.80	16.00	11.80
10	26.60	25.23	22.30	20.80	18.00	11.80
11	28.60	27.23	24.30	22.80	20.00	11.80
12	30.60	29.23	26.30	24.80	22.00	11.80
13	32.60	31.23	28.30	26.80	24.00	11.80
14	34.60	33.23	30.30	28.80	26.00	11.80
15	36.60	35.23	32.30	30.80	28.00	11.80

DATE	REV	ECN NO.	DESCRIPTION	MODIFY	APPROVAL	PROJECT	APPROVAL				PART NO.	TITLE						
2021/12/16	D	EN20211216001	Modify the first pin label	Xue	Robing	GENERAL TOLERANCE	东莞市思索技术股份有限公司 Dongguan SESO Technology Co.,Ltd.	APPROVAL	CHECK	DRAWN	DATE	2008WVS-1xXX-XXXBXXRRXXQ	TITLE					
2020/03/16	C	ER20190805001	Update Drawing Frame, The Same ECR And ECN No	Alan qin	Robing	.X ±0.30							Pitch 2.00 mm 180° SMT Wafer Connectors					
						.XX ±0.20							UNIT	SCALE	SHEET	REV	NUMBER	
						.XXX±0.10							mm	1:1	1/2	D	A-000	
						X.' ±2'	Robing	Joshua	Alan qin	2019/01/16								
						PROJECT												

RoHS

This products can apply to the SESO Doc NO. QA-3-04-005 of Environmental&Material Management Rules

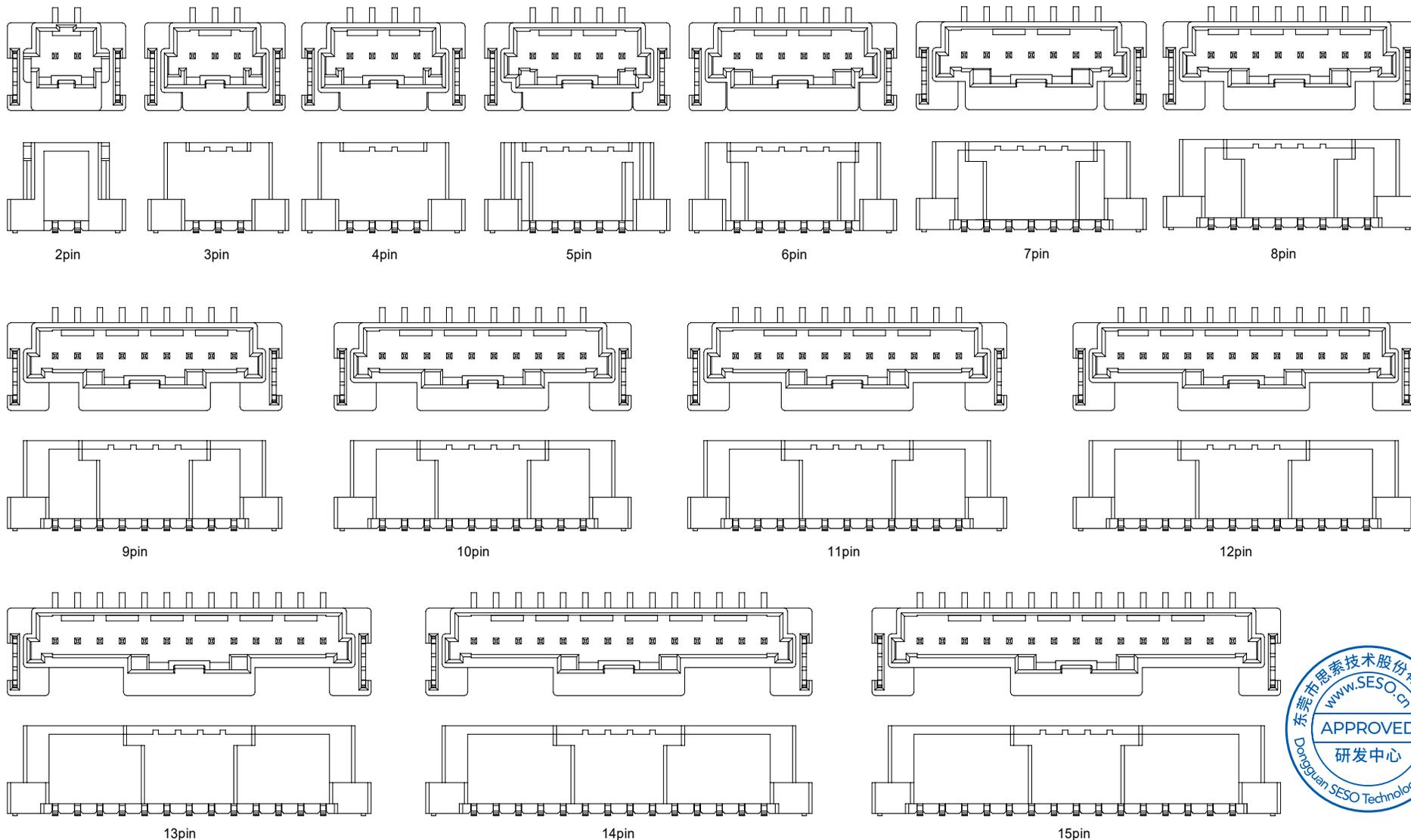

A	2021/12/16	D	EN20211216001	Modify the first pin label	Xue	Robing	东莞市思索技术股份有限公司 Dongguan SESO Technology Co.,Ltd.				PART NO. 2008WVS-1xXX-XXXBXXRXXXXQ				
	2020/03/16	C	ER20190805001	Update Drawing Frame, The Same ECR And ECN No	Alan qin	Robing					TITLE Pitch 2.00 mm 180° SMT Wafer Connectors				
	DATE	REV	ECN NO.	DESCRIPTION	MODIFY	APPROVAL	PROJECT	APPROVAL	CHECK	DRAWN	DATE	UNIT	SCALE	SHEET	REV
							Robing	Joshua	Alan qin	2019/01/16	mm	1:1	2/2	D	A-000

GENERAL TOLERANCE	
.X	±0.30
.XX	±0.20
.XXX	±0.10
X.' ±2'	
PROJECT	

RoHS

This products can apply to the SESO Doc NO. QA-3-04-005 of Environmental&Material Management Rules

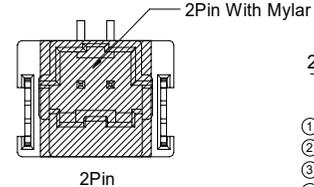
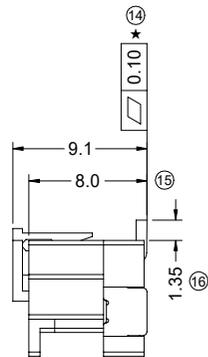
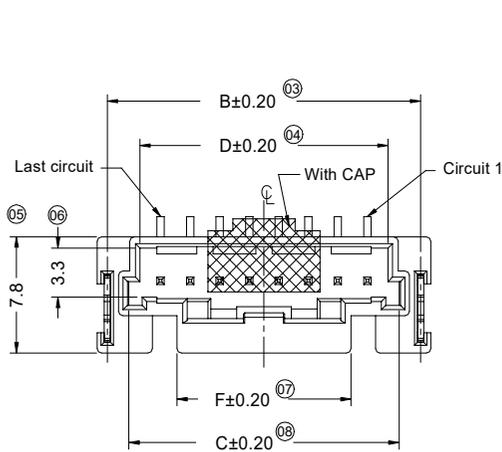
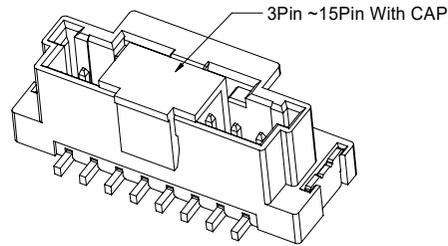
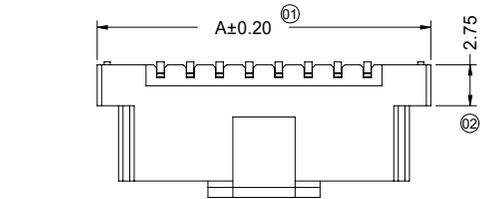

- Specifications :
- Voltage rating: 125V AC / DC
- Current rating: 3A AC / DC
- Withstanding voltage: 500V AC/minute
- Temperature range: -40°C~+125°C
- Insulation resistance: ≥1000MΩ
- Contact resistance: ≤10mΩ
- After environmental testing: ≤20mΩ
- Material(Pin): Brass
- Mates With SESO Housing: 2008H
- "★" Critical dimension

2008 W V S - 1 x XX - XX X B 05 X R XXX Q
 ① ② ③ ④ ⑤ ⑥ ⑦ ⑧ ⑨ ⑩ ⑪ ⑫ ⑬

- ① Series No.
- ② Category: W-wafer
- ③ Connector Type: V-Straight 180°
- ④ Mounting Type: S-SMT
- ⑤ Row No.-Pin No Per Row: 1xXX-Single Row 1xXXPin
- ⑥ Plastic material: 9T- PA9T 94V-0; LP- LCP 94V-0
- ⑦ Color: N-Natural; B-Black; R-Red; L-Blue
- ⑧ Metal material: B-Brass
- ⑨ Plating Code: 05-Matte Tin
- ⑩ Packing: W-Reel ,With Mylar
C-Reel , With CAP
- ⑪ RoHS/HF: R-RoHS H-Halogen-Free
- ⑫ Sequence Number: 002-Coldsealing ; 02C-Heatsealing
- ⑬ Special code :Q-Automotive Connectors

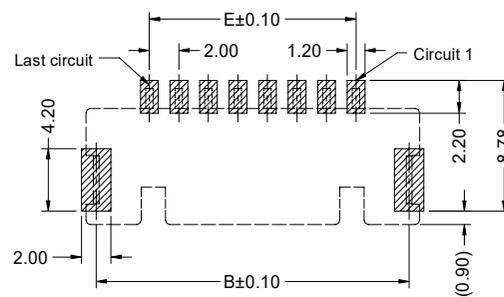
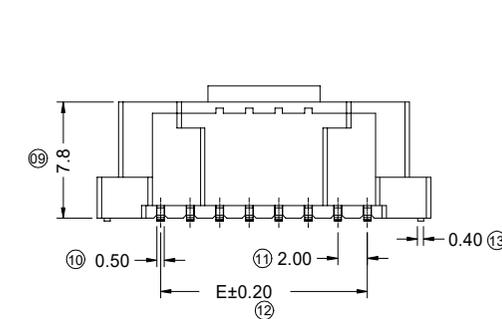

RECOMMENDED P.C.B LAYOUT (TOLERANCE:±0.05)

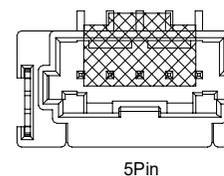
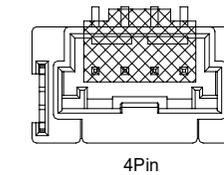
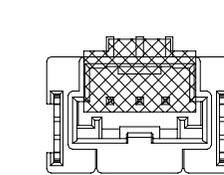

Poles	Dimensions (mm)					
	A	B	C	D	E	F
02	10.60	9.23	6.30	4.80	2.00	6.30
03	12.60	11.23	8.30	6.80	4.00	5.80
04	14.60	13.23	10.30	8.80	6.00	7.80
05	16.60	15.23	12.30	10.80	8.00	9.80
06	18.60	17.23	14.30	12.80	10.00	11.80
07	20.60	19.23	16.30	14.80	12.00	11.80
08	22.60	21.23	18.30	16.80	14.00	11.80
09	24.60	23.23	20.30	18.80	16.00	11.80
10	26.60	25.23	22.30	20.80	18.00	11.80
11	28.60	27.23	24.30	22.80	20.00	11.80
12	30.60	29.23	26.30	24.80	22.00	11.80
13	32.60	31.23	28.30	26.80	24.00	11.80
14	34.60	33.23	30.30	28.80	26.00	11.80
15	36.60	35.23	32.30	30.80	28.00	11.80

DATE	REV	ECN NO.	DESCRIPTION	MODIFY	APPROVAL	PROJECT	APPROVAL	CHECK	DRAWN	DATE	PART NO.	TITLE	UNIT	SCALE	SHEET	REV	NUMBER	
2021/12/16	F	EN20211216001	Modify the first pin label	Xue	Robing	GENERAL TOLERANCE	东莞市思索技术股份有限公司 Dongguan SESO Technology Co.,Ltd.	APPROVAL	CHECK	DRAWN	DATE	2008WVS-1xXX-XXXBXXRXXXXQ	Pitch 2.00 mm 180° SMT Wafer Connectors	mm	1:1	1/2	F	A-000
2020/03/16	E	ER20190805001	Update Drawing Frame, The Same ECR And ECN No	Alan qin	Robing	.X ±0.30												
						.XX ±0.20												
						.XXX±0.10												
						X.' ±2'	Robing	Joshua	Alan qin	2019/01/16								

RoHS

This products can apply to the SESO Doc NO. QA-3-04-005 of Environmental&Material Management Rules

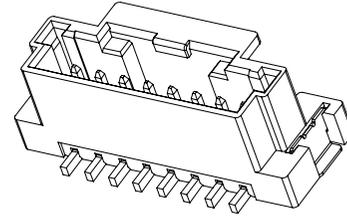

- Specifications :
- Voltage rating: 125V AC / DC
 - Current rating: 3A AC / DC
 - Withstanding voltage: 500V AC/minute
 - Temperature range: -40°C~+105°C
 - Insulation resistance: ≥1000MΩ
 - Contact resistance: ≤10mΩ
 - After environmental testing: ≤20mΩ
 - Material(Pin): Brass
 - Mates With SESO Housing: 2008H
 - "*" Critical dimension

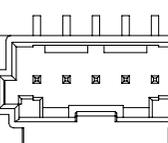
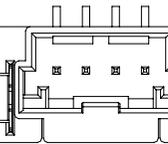
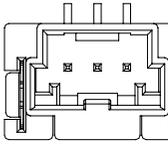
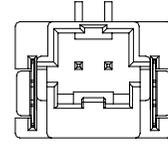
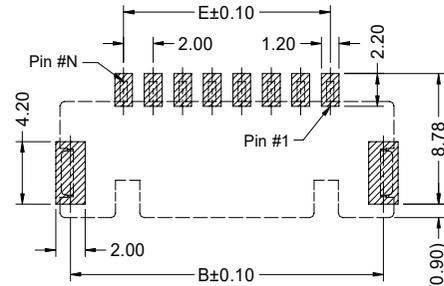
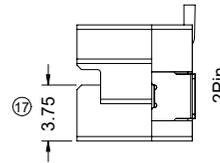
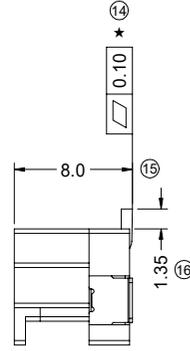
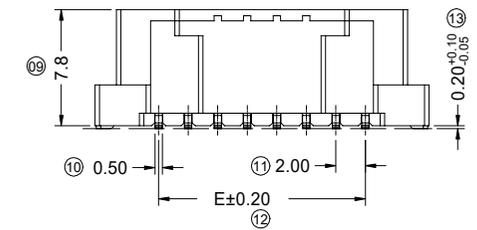
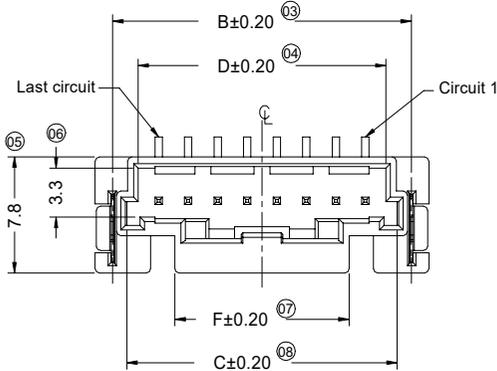
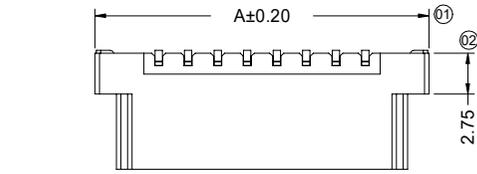

2008 W V S - XX - XX XXX X XX
① ② ③ ④ ⑤ ⑥ ⑦ ⑧ ⑨

- ① Series No.
- ② Category: W-wafer
- ③ Connector Type: V-Straight 180°
- ④ Mounting Type: S-SMT
- ⑤ Row No.-Pin No: XX-Single Row XXPin
- ⑥ Plastic material: 9T- PA9T 94V-0; LP- LCP 94V-0
- ⑦ Plating Code; SW1-Matte Tin
GW01-Contact Area: Gold flash
Solder Area: Matte Tin
- ⑧ Color: N-Natural; B-Black; R-Red; L-Blue
- ⑨ Packing: W-Reel ,With Mylar C-Reel , With CAP
R-Reel ,Without Mylar and Cap;

Poles	Dimensions (mm)					
	A	B	C	D	E	F
02	10.60	8.23	6.30	4.80	2.00	6.30
03	12.60	10.23	8.30	6.80	4.00	5.80
04	14.60	12.23	10.30	8.80	6.00	7.80
05	16.60	14.23	12.30	10.80	8.00	9.80
06	18.60	16.23	14.30	12.80	10.00	11.80
07	20.60	18.23	16.30	14.80	12.00	11.80
08	22.60	20.23	18.30	16.80	14.00	11.80
09	24.60	22.23	20.30	18.80	16.00	11.80
10	26.60	24.23	22.30	20.80	18.00	11.80
11	28.60	26.23	24.30	22.80	20.00	11.80
12	30.60	28.23	26.30	24.80	22.00	11.80
13	32.60	30.23	28.30	26.80	24.00	11.80
14	34.60	32.23	30.30	28.80	26.00	11.80
15	36.60	34.23	32.30	30.80	28.00	11.80



DATE	REV	ECN NO.	DESCRIPTION	MODIFY	APPROVAL

GENERAL TOLERANCE	.X ±0.30
	.XX ±0.20
	.XXX±0.10
	X.' ±2'
PROJECT	

SMS 东莞市思索技术股份有限公司
Dongguan SESO Technology Co.,Ltd.

APPROVAL	CHECK	DRAWN	DATE
Larry	Wang	Xue	2022/10/11

PART NO. 2008WVS-XX-XXXXXX				
TITLE Pitch 2.00 mm 180° SMT Wafer Connectors				
UNIT	SCALE	SHEET	REV	NUMBER
mm	1:1	1/2	A0	A-000

RoHS

This products can apply to the SESO Doc NO. QA-3-04-005 of Environmental&Material Management Rules

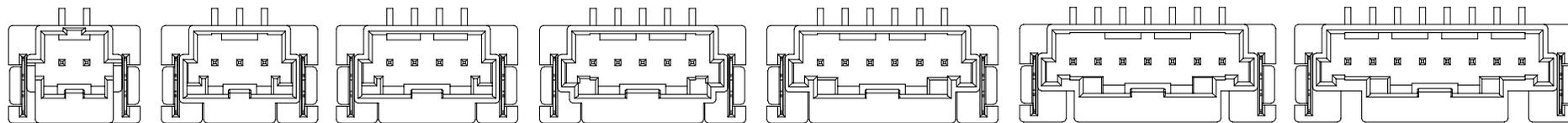

2pin 3pin 4pin 5pin 6pin 7pin 8pin

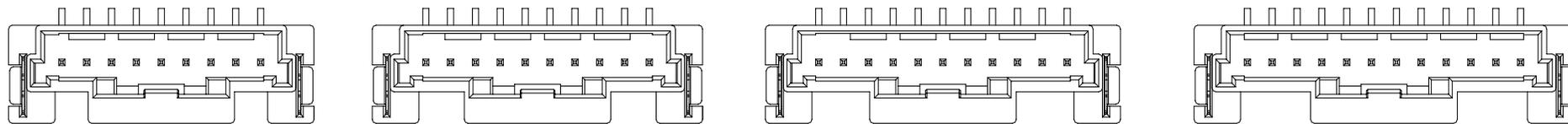

9pin 10pin 11pin 12pin

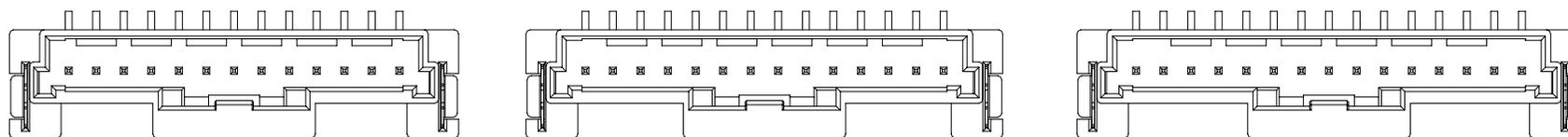

13pin 14pin 15pin



GENERAL TOLERANCE

.X ±0.30

.XX ±0.20

.XXX±0.10

X.' ±2'

PROJECT



SMS 东莞市思索技术股份有限公司
Dongguan SESO Technology Co.,Ltd.

APPROVAL CHECK DRAWN DATE

Larry Wang Xue 2022/10/11

PART NO. 2008WVS-XX-XXXXXXX

TITLE Pitch 2.00 mm 180° SMT Wafer Connectors

UNIT	SCALE	SHEET	REV	NUMBER
mm	1:1	2/2	A0	A-000

DATE	REV	ECN NO.	DESCRIPTION	MODIFY	APPROVAL