

RoHS

This products can apply to the SESO Doc NO. QA-3-04-005 of Environmental&Material Management Rules

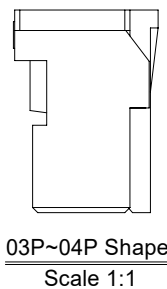
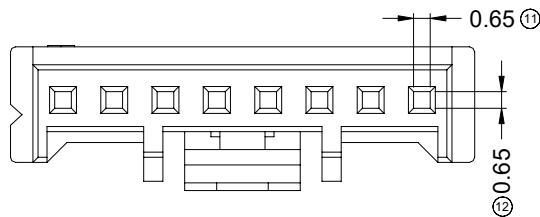
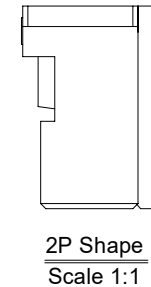
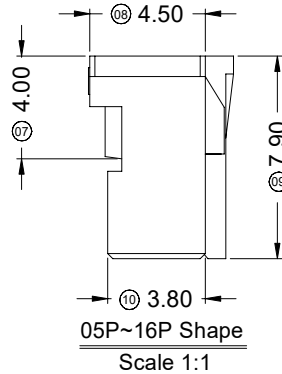
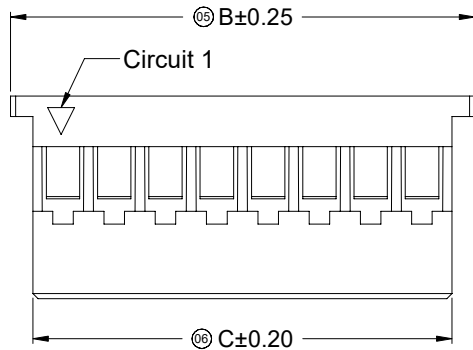
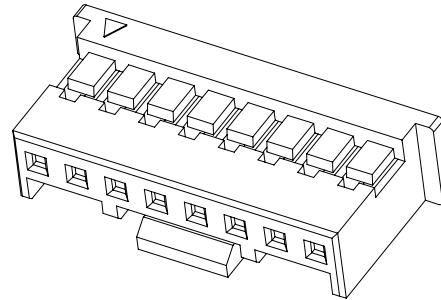
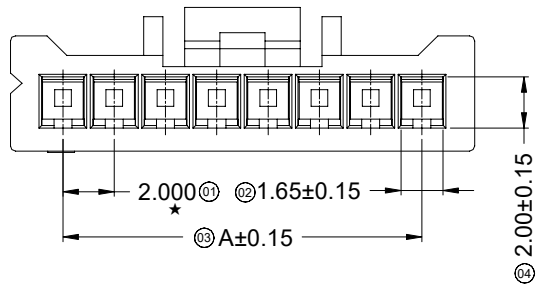

■ Specifications :

- Voltage rating: 250V AC / DC
- Current rating: 3A AC / DC
- Withstanding voltage: 800V AC/minute
- Temperature range: -40°C~+105°C
- Insulation resistance: ≥1000MΩ
- Contact resistance: ≤10mΩ
- After environmental testing: ≤20mΩ
- "\*" Critical dimension

- Suitable SESO Terminal: 2000T
- Suitable SESO Wafer: 2000W

2000 H X-XX X-N0 XX XX

① ② ③ ④ ⑤ ⑥ ⑦ ⑧

- ① Series No.
- ② Category: H-HSG
- ③ Appearance type: Blank-Ordinary
- ④ Row No.-Pin No.: XX-02P~16P
- ⑤ Plug the Pin & Special No.: Blank-Ordinary
- ⑥ Material : N0-PA66 94V-0
- ⑦ Blank-Ordinary ; HF-Halogen Free
- ⑧ Blank-Natural ; BK-Black; RE-Red

Poles	Dimensions (mm)			Poles	Dimensions (mm)		
	A	B	C		A	B	C
02	2.00	6.10	4.34	10	18.00	22.10	20.34
03	4.00	8.10	6.34	11	20.00	24.10	22.34
04	6.00	10.10	8.34	12	22.00	26.10	24.34
05	8.00	12.10	10.34	13	24.00	28.10	26.34
06	10.00	14.10	12.34	14	26.00	30.10	28.34
07	12.00	16.10	14.34	15	28.00	32.10	30.34
08	14.00	18.10	16.34	16	30.00	34.10	32.34
09	16.00	20.10	18.34				

DATE	REV	ECN NO.	DESCRIPTION	MODIFY	APPROVAL	PROJECT	APPROVAL	CHECK	DRAWN	DATE	PART NO.	UNIT	SCALE	SHEET	REV	NUMBER
2023/06/14	K1		Update Drawing Frame	Lisf	Larry	GENERAL TOLERANCE					<b>SMS 东莞市思索技术股份有限公司</b> Dongguan SESO Technology Co.,Ltd.	2000H-XX-N0XXXX	1:1	1/1	K1	A-022
2020/03/19	K	EN20200319001	Update Drawing Frame	Wzbin	Roving											
2019/02/23	J	EN20190223001	Add Poles to different appearance diagrams	Alan qin	Smarm											

RoHS

This products can apply to the SESO Doc NO. QA-3-04-005 of Environmental&Material Management Rules

■ Specifications :

- Voltage rating: 250V AC / DC
- Current rating: 3A AC / DC
- Withstanding voltage: 800V AC/minute
- Temperature range: -40°C~+105°C
- Insulation resistance: ≥1000MΩ
- Contact resistance: ≤10mΩ
- After environmental testing: ≤20mΩ
- Used In SESO Housing: 2000H
- "★" Critical dimension

2000 T X-P XX X-X  
① ② ③ ④ ⑤ ⑥ ⑦

- ① Series No.
- ② Category: T-Terminal
- ③ Appearance type: Blank-Ordinary; H-High feet; L-Low feet
- ④ Material: P-Phosphor bronze
- ⑤ Plating Code: G01-Contact Gold 1u"  
G03-Contact Gold 3u"  
SN-Bright Tin Plating
- ⑥ Plating Method : Blank-Stamping before Plating
- ⑦ Mold No./Mark/Special No.

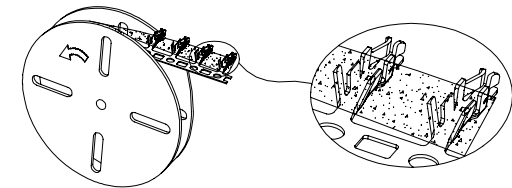
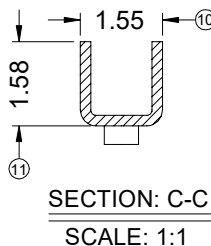
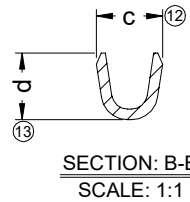
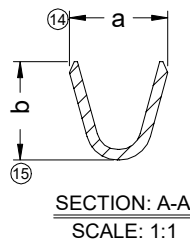
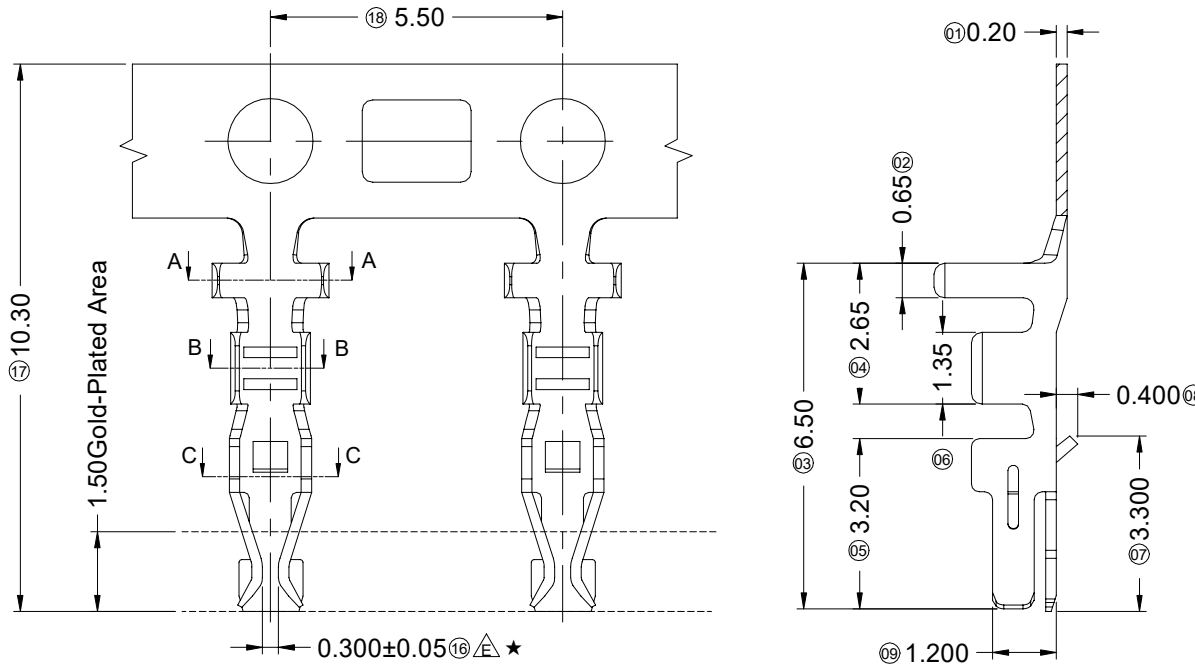

卷装方式

SCALE 4:1

2000TH-PXXX	Phosphor bronze	AWG#20-22 (0.5-0.35mm <sup>2</sup> )	1.50mm(Max)	2.20	2.50	1.80	1.80
2000T-PXXX		AWG#22-24 (0.35-0.22mm <sup>2</sup> )	1.50mm(Max)	2.20	2.50	1.50	1.60
2000TL-PXXX		AWG#26-30 (0.128-0.05mm <sup>2</sup> )	1.00mm(Max)	1.85	1.85	1.25	1.25
P/N	Material	Wire Size	Insulation O.D	DIM a	DIM b	DIM c	DIM d

2023/06/14	G1		Update Drawing Frame	Lisf	Larry Yang	<b>GENERAL TOLERANCE</b> .X ±0.30 .XX ±0.20 .XXX ±0.10 X° ±2° <b>PROJECT</b> 
2022/04/20	G	ER20220418003	Change low foot pressure line specification	Xuexiaolong	Robing	
2020/03/19	F	EN20200319001	Update Drawing Frame	Wzbin	Robing	
<b>DATE</b>	<b>REV</b>	<b>ECN NO</b>	<b>DESCRIPTION</b>	<b>MODIFY</b>	<b>APPROVAL</b>	

**SMS** 东莞市思索技术股份有限公司  
Dongguan SESO Technology Co.,Ltd.

<b>APPROVAL</b>	<b>CHECK</b>	<b>DRAWN</b>	<b>DATE</b>
Jack Zhang	Larry Yang	Jacky	2014/05/05

<b>PART NO.</b> 2000TX-PXXX-X				
<b>TITLE</b> 2.00mm Crimp Style Connectors				
<b>UNIT</b>	<b>SCALE</b>	<b>SHEET</b>	<b>REV</b>	<b>NUMBER</b>
mm	1:1	1/1	G1	A-014

RoHS

This products can apply to the SESO Doc NO. QA-3-04-005 of Environmental&Material Management Rules

RD-1

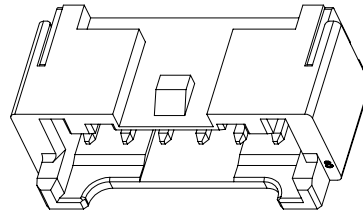
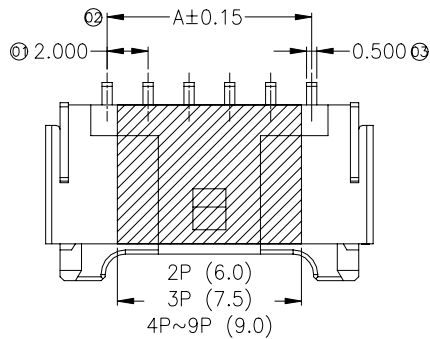

Specifications :

- Voltage rating: 250V AC / DC
- Current rating: 3A AC / DC
- Withstanding voltage: 800V AC/minute
- Temperature range: -40°C~+125°C
- Insulation resistance: ≥1000MΩ
- Contact resistance: ≤10mΩ
- After environmental testing: ≤20mΩ
- Material(Pin): Brass
- Material(Solder Tabs): Brass
- Mates With SESO Housing 2000H

P/N system:

2000 W R S-XX X-XX SW XX X XX  
① ② ③ ④ ⑤ ⑥ ⑦ ⑧ ⑨ ⑩ ⑪

- ① Series No.
- ② Category: W-WAFER
- ③ Connector type: R-Right Angle 90°
- ④ Mouting type: S-SMT
- ⑤ Row No.-Pin No per row: XX-02P~16P
- ⑥ Special No.
- ⑦ Material: 9T-PA9T 94V-0; LP-LCP 94V-0
- ⑧ Plating code: SW-Matte Tin GW3-Contact point gold 3u"
- ⑨ Color : Blank-Natural Color ; BK-Black Color
- ⑩ Packing: Blank-Reel ,With Mylar  
R-Reel ,Without Mylar
- ⑪ Cover tape type: Blank-Adhesive ; RQ-Heat sealing

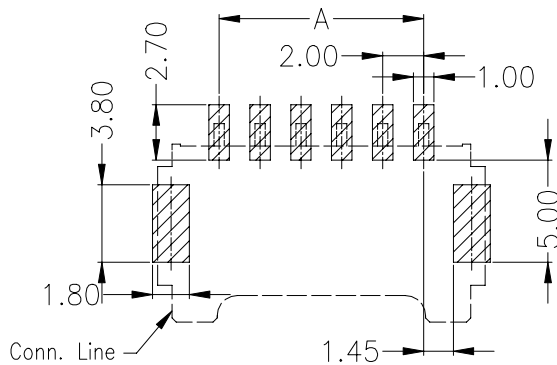
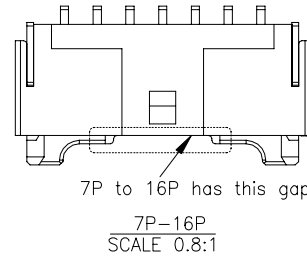
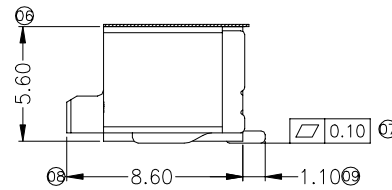
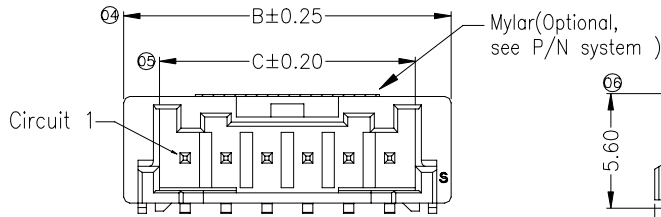

Recommended P.C.B Layout  
General Tolerance±0.05

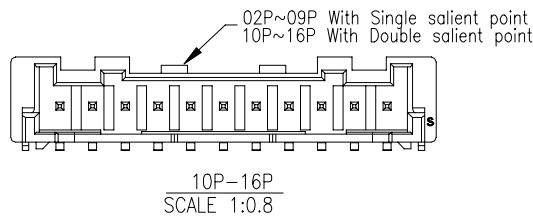
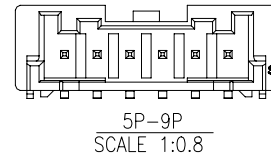
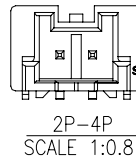

Poles	Dimensions (mm)			Poles	Dimensions (mm)		
	A	B	C		A	B	C
02	2.00	8.00	4.50	10	18.00	24.00	20.50
03	4.00	10.00	6.50	11	20.00	26.00	22.50
04	6.00	12.00	8.50	12	22.00	28.00	24.50
05	8.00	14.00	10.50	13	24.00	30.00	26.50
06	10.00	16.00	12.50	14	26.00	32.00	28.50
07	12.00	18.00	14.50	15	28.00	34.00	30.50
08	14.00	20.00	16.50	16	30.00	36.00	32.50
09	16.00	22.00	18.50				

2023/06/14	N1		Update Drawing Frame	LXZ	Larry Yang	东莞市思索技术股份有限公司 Dongguan SESO Technology Co.,Ltd.				PART NO. 2000WRS-XX-XXSWXXX							
2022/09/09	N		Added half gold plated 3U "specification	Xuexiaolong	Larry					TITLE 2.00mm Crimp Style Connector							
2020/09/23	M	EN120200923001	Add P/N for heat sealing cover tape	TengMin	Harvey Yan					APPROVAL	CHECK	DRAWN	DATE	UNIT SCALE SHEET REV NUMBER			
DATE	REV	ECN NO	DESCRIPTION	MODIFY	APPROVAL					Jack Zhang	Larry Yang	Alan qin	2014/05/05	mm	3:1	1/1	N1

RoHS

This products can apply to the SESO Doc NO. QA-3-04-005 of Environmental&Material Management Rules

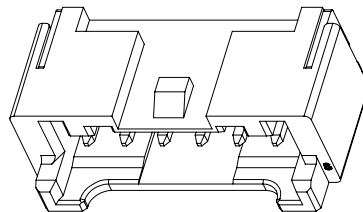
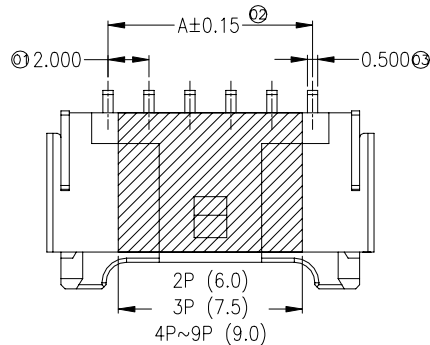

Specifications :

- Voltage rating: 250V AC / DC
- Current rating: 3A AC / DC
- Withstanding voltage: 800V AC/minute
- Temperature range: -40°C~+125°C
- Insulation resistance: >1000MΩ
- Contact resistance: <10mΩ
- After environmental testing: <20mΩ
- "★" Critical dimension
- Material(Pin): Brass
- Material(Solder Tabs): Brass
- Mates With SESO Housing: 2000H

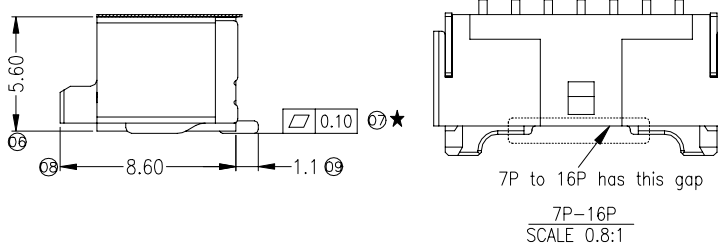
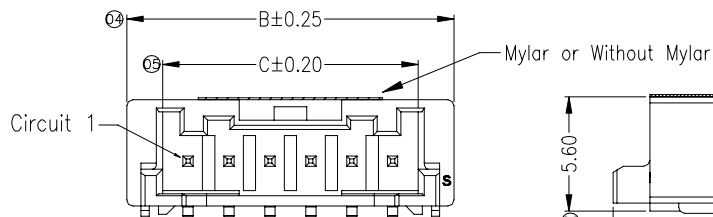

2000 W R S-XX X-XX SWXX X-S  
① ② ③ ④ ⑤ ⑥ ⑦ ⑧ ⑨ ⑩

- ① Series No.
- ② Category: W-WAFER
- ③ Connector type: R-Right Angle 90°
- ④ Mouting type: S-SMT
- ⑤ Row No.-Pin No per row: XX=02P~16P
- ⑥ Special No.
- ⑦ Material: 9T -PA9T 94V-0; LP -LCP 94V-0
- ⑧ Plating code: SW- Matte Tin GW3-Contact point gold 3u"
- ⑨ Color : Blank-Natural Color ; BK-Black Color
- ⑩ Packing: Blank-Reel ,02~09P With Mylar; 10~16P Without Mylar R-Reel ,02~09P Without Mylar

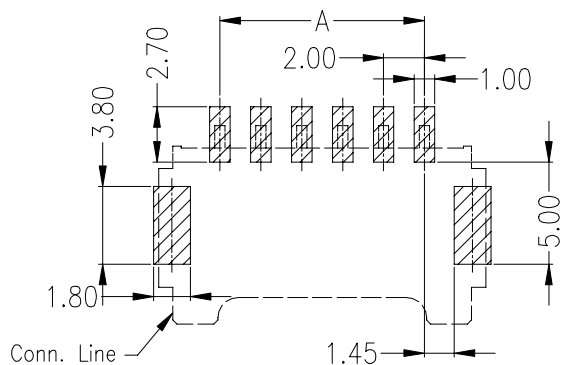

Recommended P.C.B Layout  
General Tolerance±0.05

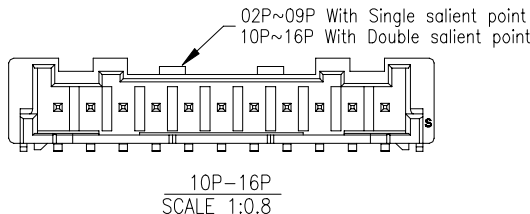
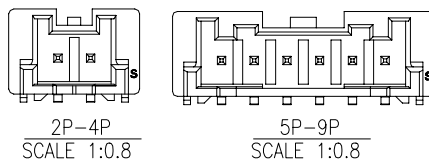

Poles	Dimensions (mm)			Poles	Dimensions (mm)		
	A	B	C		A	B	C
02	2.00	8.00	4.50	10	18.00	24.00	20.50
03	4.00	10.00	6.50	11	20.00	26.00	22.50
04	6.00	12.00	8.50	12	22.00	28.00	24.50
05	8.00	14.00	10.50	13	24.00	30.00	26.50
06	10.00	16.00	12.50	14	26.00	32.00	28.50
07	12.00	18.00	14.50	15	28.00	34.00	30.50
08	14.00	20.00	16.50	16	30.00	36.00	32.50
09	16.00	22.00	18.50				

DATE	REV	ECN NO.	DESCRIPTION	MODIFY	APPROVAL	PROJECT
2023/06/14	M1		Update Drawing Frame	LXZ	Larry Yang	GENERAL TOLERANCE
2022/09/09	M		Added half gold plated 3U "specification	xuexiaolong	Larry	.X ±0.30
2020/03/20	L	EN20200319001	Update Drawing Frame	Wzbin	Robing	.XX ±0.20
						.XXX±0.10
						X.' ±2'
						PROJECT

**SMS** 东莞市思索技术股份有限公司  
Dongguan SESO Technology Co.,Ltd.

APPROVAL: Jack Zhang  
CHECK: Larry Yang  
DRAWN: Alan qin  
DATE: 2014/05/05

PART NO. 2000WRS-XX-XXSWXXX-S				
TITLE 2.00mm Crimp Style Connector				
UNIT	SCALE	SHEET	REV	NUMBER
mm	1:1	1/1	M1	A-000

RoHS

This products can apply to the SESO Doc NO. QA-3-04-005 of Environmental&Material Management Rules

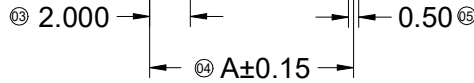
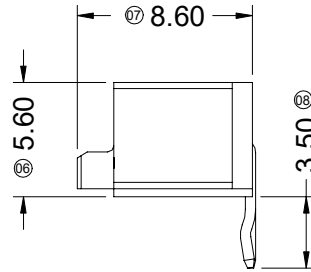
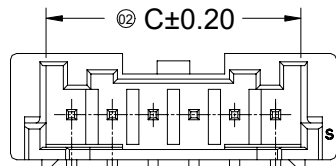
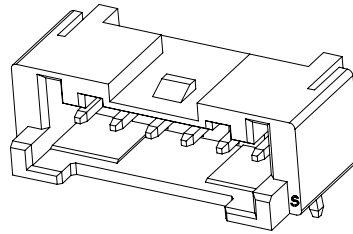
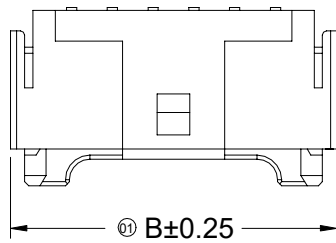

Specifications :

- Voltage rating: 250V AC / DC
- Current rating: 3A AC / DC
- Withstanding voltage: 800V AC/minute
- Temperature range: -40°C~+105°C
- Insulation resistance: ≥1000MΩ
- Contact resistance: ≤10mΩ
- After environmental testing: ≤20mΩ
- Material(Pin): Brass
- Mates With SESO Housing: 2000H

2000 W R X-XX X -9T SN XX  
① ② ③ ④ ⑤ ⑥ ⑦ ⑧ ⑨

- ① Series No.
- ② Category: W-WAFER
- ③ Welding Board Angle: R-Right Angle 90°
- ④ Welding Way: Blank-DIP
- ⑤ Row No.-Pin No.: XX-02P~16P
- ⑥ Plug the Pin & Special No.
- ⑦ Material: 9T -PA9T 94V-0
- ⑧ Plating Code: SN-Bright Tin Plating
- ⑨ Color : Blank-Natural Color

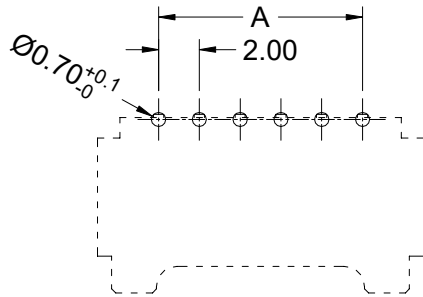

Recommended P.C.B Layout  
General Tolerance±0.05

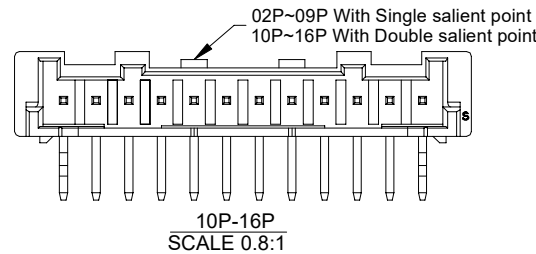
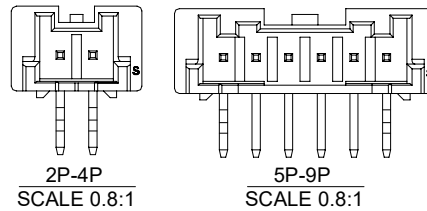

Poles	Dimensions (mm)			Poles	Dimensions (mm)		
	A	B	C		A	B	C
02	2.00	8.00	4.50	10	18.00	24.00	20.50
03	4.00	10.00	6.50	11	20.00	26.00	22.50
04	6.00	12.00	8.50	12	22.00	28.00	24.50
05	8.00	14.00	10.50	13	24.00	30.00	26.50
06	10.00	16.00	12.50	14	26.00	32.00	28.50
07	12.00	18.00	14.50	15	28.00	34.00	30.50
08	14.00	20.00	16.50	16	30.00	36.00	32.50
09	16.00	22.00	18.50				

DATE	REV	ECN NO	DESCRIPTION	MODIFY	APPROVAL	PROJECT
2023/06/14	C1		Update Drawing Frame	Lisf	Larry	GENERAL TOLERANCE
2020/05/22	C		Modify temperature	Roy.Hu	Robing	.X ±0.30
2020/03/19	B	EN20200319001	Update Drawing Frame	Wzbin	Robing	.XX ±0.20
						.XXX ±0.10
						X.° ±2°
						APPROVAL
						CHECK
						DRAWN
						DATE
						Jack Zhang
						Larry Yang
						Alan qin
						2018/09/04

**SMS** 东莞市思索技术股份有限公司  
Dongguan SESO Technology Co.,Ltd.

PART NO. 2000WR-XX-9TSN				
TITLE 2.00mm Crimp Style Connector				
UNIT	SCALE	SHEET	REV	NUMBER
mm	1:1	1/1	C1	A-000

RoHS

This products can apply to the SESO Doc NO. QA-3-04-005 of Environmental&Material Management Rules

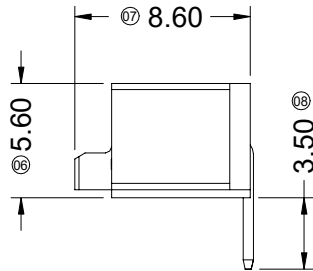
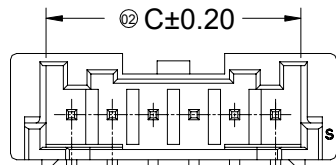
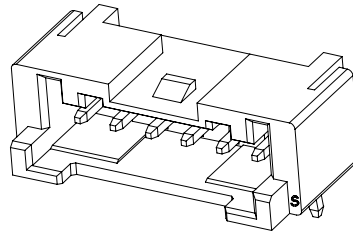
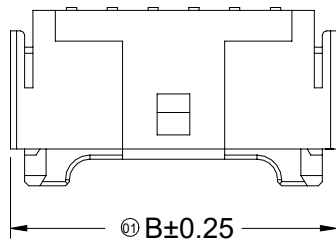

Specifications :

- Voltage rating: 250V AC / DC
- Current rating: 3A AC / DC
- Withstanding voltage: 800V AC/minute
- Temperature range: -40°C~+105°C
- Insulation resistance: ≥1000MΩ
- Contact resistance: ≤10mΩ
- After environmental testing: ≤20mΩ
- Material(Pin): Brass
- Mates With SESO Housing: 2000H

2000 W R X-XX A -9T SN XX

① ② ③ ④ ⑤ ⑥ ⑦ ⑧ ⑨

- ① Series No.
- ② Category: W-WAFER
- ③ Welding Board Angle: R-Right Angle 90°
- ④ Welding Way: Blank-DIP
- ⑤ Row No.-Pin No.: XX-02P~16P
- ⑥ Plug the Pin & Special No.: A-Without kink
- ⑦ Material: 9T -PA9T 94V-0
- ⑧ Plating Code: SN-Bright Tin Plating
- ⑨ Color : Blank-Natural Color

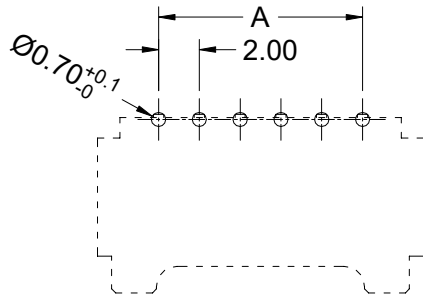
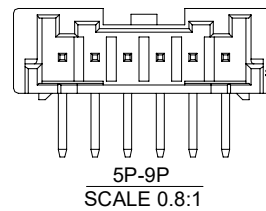
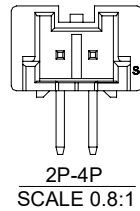
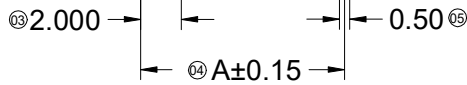

Recommended P.C.B Layout  
General Tolerance±0.05

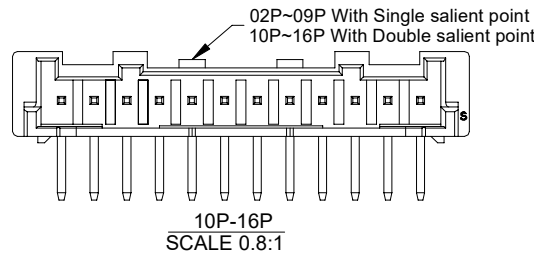

Poles	Dimensions (mm)			Poles	Dimensions (mm)		
	A	B	C		A	B	C
02	2.00	8.00	4.50	10	18.00	24.00	20.50
03	4.00	10.00	6.50	11	20.00	26.00	22.50
04	6.00	12.00	8.50	12	22.00	28.00	24.50
05	8.00	14.00	10.50	13	24.00	30.00	26.50
06	10.00	16.00	12.50	14	26.00	32.00	28.50
07	12.00	18.00	14.50	15	28.00	34.00	30.50
08	14.00	20.00	16.50	16	30.00	36.00	32.50
09	16.00	22.00	18.50				

DATE	REV	ECN NO	DESCRIPTION	MODIFY	APPROVAL	PROJECT	APPROVAL	CHECK	DRAWN	DATE	PART NO. 2000WR-XXA-9TSN					
2023/06/14	C1		Update Drawing Frame	Lisf	Larry Yang	GENERAL TOLERANCE	东莞市思索技术股份有限公司 Dongguan SESO Technology Co.,Ltd.	APPROVAL	CHECK	DRAWN	DATE	TITLE				
2020/05/22	C		Modify temperature	Roy.Hu	Robing	2.00mm Crimp Style Connector										
2020/03/19	B	EN20200319001	Update Drawing Frame	Wzbin	Robing	UNIT						SCALE	SHEET	REV	NUMBER	
						mm						1:1	1/1	C1	A-000	

RoHS

This products can apply to the SESO Doc NO. QA-3-04-005 of Environmental&Material Management Rules

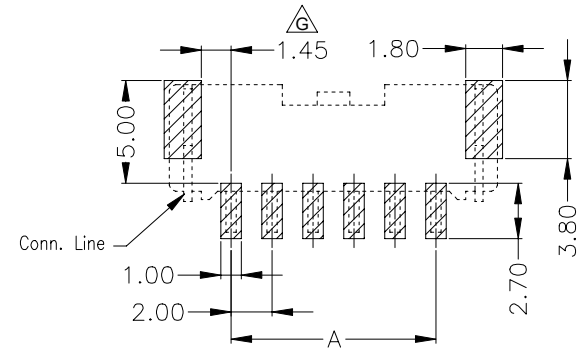
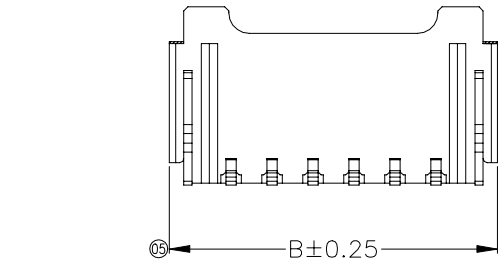
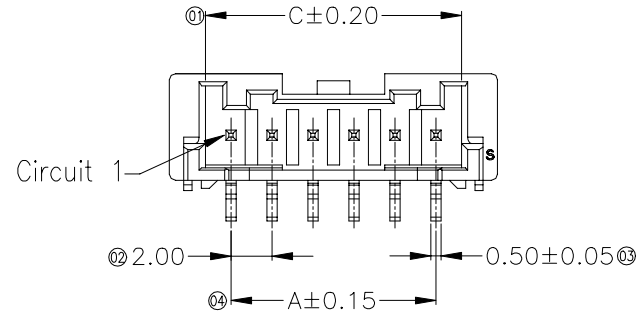

Recommended P.C.B Layout  
General Tolerance±0.05

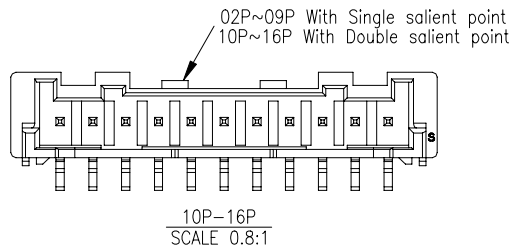
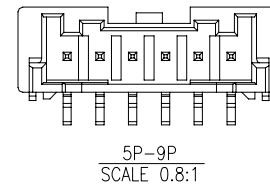
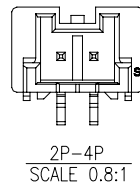
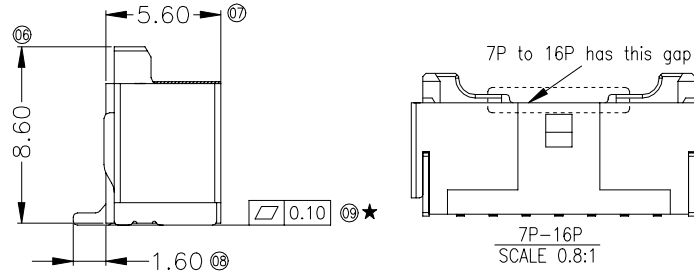
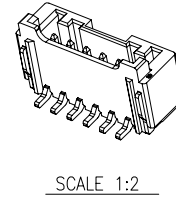
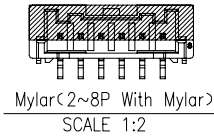
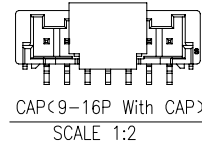

Specifications :

- Voltage rating: 250V AC / DC
- Current rating: 3A AC / DC
- Withstanding voltage: 800V AC/minute
- Temperature range: -40°C~+125°C
- Insulation resistance: ≥1000MΩ
- Contact resistance: <10mΩ
- After environmental testing: <20mΩ
- Material(Pin): Brass
- Material(Solder Tabs): Brass
- Mates With SESO Housing: 2000H
- "★" Critical dimension

2000 W V S-XX X-9T SW XX X-S  
① ② ③ ④ ⑤ ⑥ ⑦ ⑧ ⑨ ⑩ ⑪

- ① Series No.
- ② Category: W-WAFER
- ③ Connector type: V-Stright 180°
- ④ Mouting type: S-SMT
- ⑤ Pin number: XX-02P~16P
- ⑥ Plug the Pin & Special No.  
Blank-With Mylar C- With CAP
- ⑦ Material: 9T -PA9T 94V-0
- ⑧ Plating Code: SW-Matte Tin
- ⑨ Color : Blank-Natural ; BK-Black
- ⑩ Packing: Blank-Reel ,2~8P With Mylar  
9-16P With CAP  
R-Reel ,Without Mylar&CAP

⑪ Special NO:S

Poles	Dimensions (mm)			Poles	Dimensions (mm)		
	A	B	C		A	B	C
02	2.00	8.00	4.50	10	18.00	24.00	20.50
03	4.00	10.00	6.50	11	20.00	26.00	22.50
04	6.00	12.00	8.50	12	22.00	28.00	24.50
05	8.00	14.00	10.50	13	24.00	30.00	26.50
06	10.00	16.00	12.50	14	26.00	32.00	28.50
07	12.00	18.00	14.50	15	28.00	34.00	30.50
08	14.00	20.00	16.50	16	30.00	36.00	32.50
09	16.00	22.00	18.50				

2023/06/14	J1		Update Drawing Frame	lxz	Larry Yang	<b>SMS</b> 东莞市思索技术股份有限公司 Dongguan SESO Technology Co.,Ltd.	APPROVAL    CHECK    DRAWN    DATE	PART NO. 2000WVS-XXX-9TSWXXX-S						
2022/02/21	J	EN20211006001	Change the suction cover structure	Xue	John Yang			TITLE 2.00mm Crimp Style Connector						
2020/03/19	I	EN20200319001	Update Drawing Frame	Wzbin	Robing			UNIT    SCALE    SHEET    REV    NUMBER						
DATE	REV	ECN NO.	DESCRIPTION	MODIFY	APPROVAL			Jack Zhang	Larry Yang	Xue	2018/05/31	mm	1:1	1/1

RoHS

This products can apply to the SESO Doc NO. QA-3-04-005 of Environmental&Material Management Rules

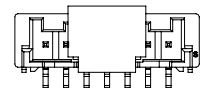
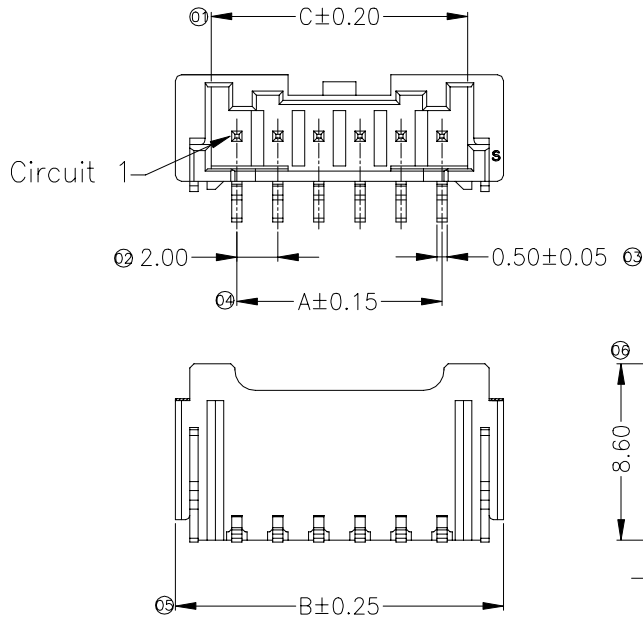

CAP(9-16P With CAP)  
SCALE 1:2

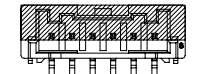

Mylar(2~8P With Mylar)  
SCALE 1:2

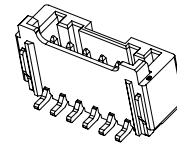

SCALE 1:2

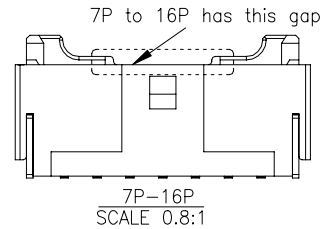
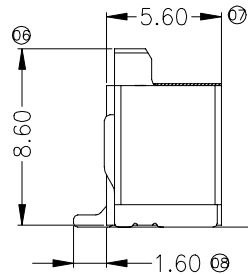

7P-16P  
SCALE 0.8:1

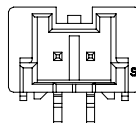

2P-4P  
SCALE 0.8:1

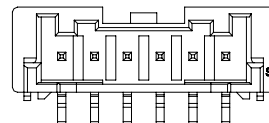

5P-9P  
SCALE 0.8:1

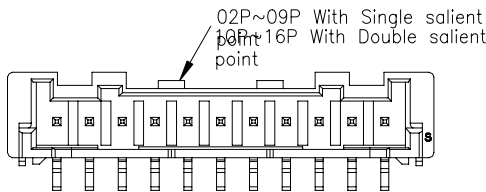

10P-16P  
SCALE 0.8:1

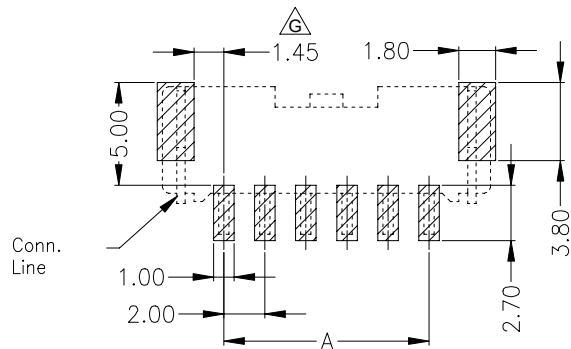

Recommended P.C.B Layout  
General Tolerance±0.05

Specifications :

- Voltage rating: 250V AC / DC
- Current rating: 3A AC / DC
- Withstanding voltage: 800V AC/minute
- Temperature range: -40°C~+125°C
- Insulation resistance: ≥1000MΩ
- Contact resistance: ≤10mΩ
- After environmental testing: ≤20mΩ
- Material(Pin): Brass
- Material(Solder Tabs): Brass
- Mates With SESO Housing: 2000H
- "★" Critical dimension

2000 W V S-XX X -9T SW XX X XX

① ② ③ ④ ⑤ ⑥ ⑦ ⑧ ⑨ ⑩ ⑪

- ① Series No.
- ② Category: W-WAFER
- ③ Connector type: V-Stright 180°
- ④ Mouting type: S-SMT
- ⑤ Pin number: XX-02P~16P
- ⑥ Plug the Pin & Special No.:  
Blank-With Mylar , C-9-16P With CAP
- ⑦ Material: 9T -PA9T 94V-0  
LP -LCP 94V-0
- ⑧ Plating Code:SW-Matte Tin ; G03-Contact Area Gold 3u"
- ⑨ Color : Blank-Natural ; BK-Black
- ⑩ Packing: Blank-Reel ,2~8P With Mylar  
R-Reel ,Without Mylar&CAP
- ⑪ Cover tape type: Blank-Adhesive ; RQ- Heat sealing



Poles	Dimensions (mm)			Poles	Dimensions (mm)		
	A	B	C		A	B	C
02	2.00	8.00	4.50	10	18.00	24.00	20.50
03	4.00	10.00	6.50	11	20.00	26.00	22.50
04	6.00	12.00	8.50	12	22.00	28.00	24.50
05	8.00	14.00	10.50	13	24.00	30.00	26.50
06	10.00	16.00	12.50	14	26.00	32.00	28.50
07	12.00	18.00	14.50	15	28.00	34.00	30.50
08	14.00	20.00	16.50	16	30.00	36.00	32.50
09	16.00	22.00	18.50				

2023/06/14	K1		Update Drawing Frame	lxz	Larry Yang	<b>GENERAL TOLERANCE</b> .X ±0.30 .XX ±0.20 .XXX ±0.10 X° ±2° <b>PROJECT</b> 	<b>APPROVAL</b> <b>CHECK</b> <b>DRAWN</b> <b>DATE</b> Jack Zhang    Larry Yang    Alan qin    2018/05/31			
2022/02/21	K	EN20211006001	Change the suction cover structure	Xue	John Yang					
2021/02/27	J	EN120210227001	Add P/N for heat sealing cover tape and plating code	TengMin	John Yang					
<b>DATE</b>	<b>REV</b>	<b>ECN NO</b>	<b>DESCRIPTION</b>	<b>MODIFY</b>	<b>APPROVAL</b>					
1	2	3	4	5	6					

**SMS** 东莞市思索技术股份有限公司  
Dongguan SESO Technology Co.,Ltd.

**PART NO.**  
2000WVS-XXX-9TSWXXXX

<b>TITLE</b> 2.00mm Crimp Style Connector				
<b>UNIT</b>	<b>SCALE</b>	<b>SHEET</b>	<b>REV</b>	<b>NUMBER</b>
mm	1:1	1/1	K1	A-000

1 2 3 4 5 6 7 8



RoHS

This products can apply to the SESO Doc NO. QA-3-04-005 of Environmental&Material Management Rules

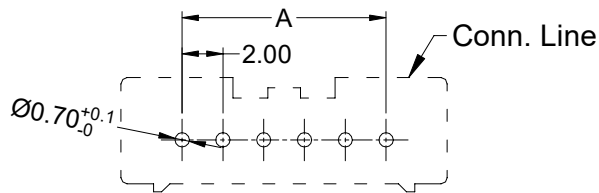
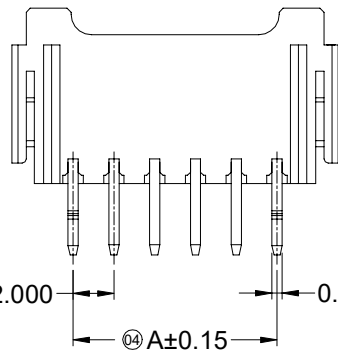
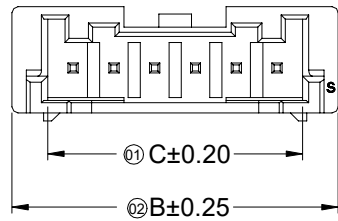

Recommended P.C.B Layout  
General Tolerance±0.05

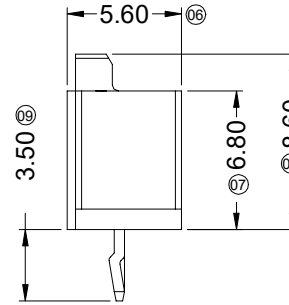
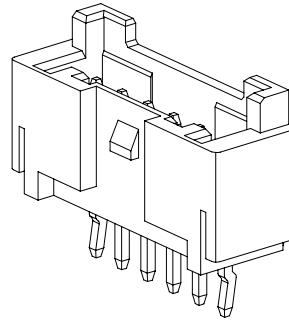

Specifications :

- Voltage rating: 250V AC / DC
- Current rating: 3A AC / DC
- Withstanding voltage: 800V AC/minute
- Temperature range: -40°C~+105°C
- Insulation resistance:≥1000MΩ
- Contact resistance: ≤10mΩ
- After environmental testing: ≤20mΩ
- Material(Pin): Brass
- Mates With SESO Housing: 2000H

2000 W V X-XX X -9T SN XX  
① ② ③ ④ ⑤ ⑥ ⑦ ⑧ ⑨

- ① Series No.
- ② Category: W-WAFER
- ③ Welding Board Angle: V- Stright 180° ;
- ④ Welding Way: Blank-DIP
- ⑤ Row No.-Pin No.: XX-02P~16P
- ⑥ Plug the Pin & Special No.: With Kink
- ⑦ Material: 9T -PA9T 94V-0
- ⑧ Plating Category: SN-Bright Tin Plating
- ⑨ Color : Blank-Natural Color

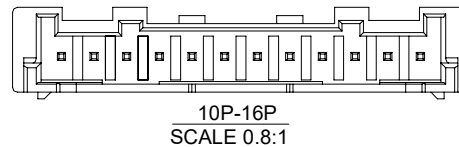
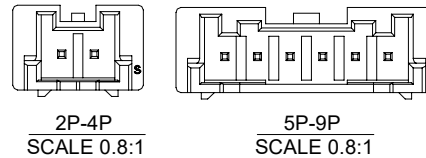

Poles	Dimensions (mm)			Poles	Dimensions (mm)		
	A	B	C		A	B	C
02	2.00	8.00	4.50	10	18.00	24.00	20.50
03	4.00	10.00	6.50	11	20.00	26.00	22.50
04	6.00	12.00	8.50	12	22.00	28.00	24.50
05	8.00	14.00	10.50	13	24.00	30.00	26.50
06	10.00	16.00	12.50	14	26.00	32.00	28.50
07	12.00	18.00	14.50	15	28.00	34.00	30.50
08	14.00	20.00	16.50	16	30.00	36.00	32.50
09	16.00	22.00	18.50				

2023/06/14	C1		Update Drawing Frame	LXZ	Larry Yang	<b>GENERAL TOLERANCE</b> .X ±0.30 .XX ±0.20 .XXX ±0.10 X.° ±2° <b>PROJECT</b> 	<b>SMS 东莞市思索技术股份有限公司</b> Dongguan SESO Technology Co.,Ltd.				PART NO. 2000WV-XX-9TSN				
2020/05/22	C		Modify temperature	Roy.Hu	Robing						<b>APPROVAL</b> <b>CHECK</b> <b>DRAWN</b> <b>DATE</b>				<b>TITLE</b> 2.00mm Crimp Style Connector
2020/03/19	B	EN20200319001	Update Drawing Frame	Wzbin	Robing		Jack Zhang	Larry Yang	Alan qin	2018/09/04	UNIT	SCALE	SHEET	REV	NUMBER
DATE	REV	ECN NO	DESCRIPTION	MODIFY	APPROVAL		mm	1:1	1/1	C1	A-000				