

RoHS

This products can apply to the SESO Doc NO. QA-3-04-005 of Environmental&Material Management Rules

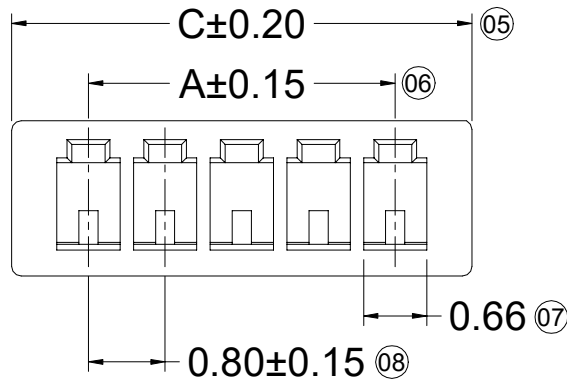
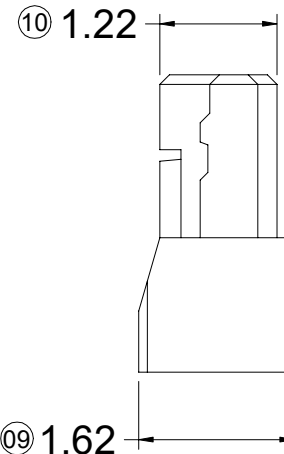
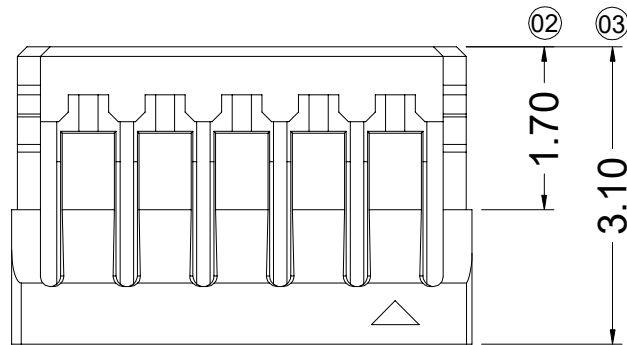
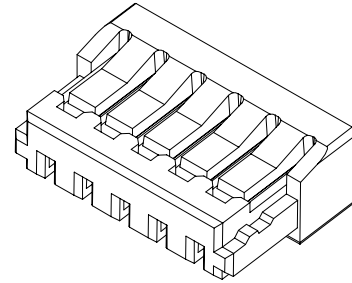
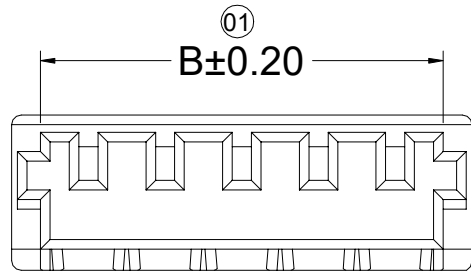

■ Specifications :

- Voltage rating: 30V AC / DC
- Current rating: 0.50A AC / DC
- Withstanding voltage: 200V AC/minute
- Temperature range: -40°C~+105°C
- Insulation resistance: ≥100MΩ
- Contact resistance: ≤20mΩ
- After environmental testing: ≤40mΩ
- Suitable SESO Terminal: 0800T
- Mates With SESO Wafer: 0800W

0800 H X - XX X - 46 XX
 ① ② ③ ④ ⑤ ⑥ ⑦

- ① Series No.
- ② Category: H-HSG
- ③ Connector type: Blank-ordinary
- ④ Row No.-Pin No per row: XX-Single row
- ⑤ Special No:Blank-Without Ears
- ⑥ Material : 46-PA46 94V-0
- ⑦ RoHS: Blank-RoHS , HF-Halogen-Free
- ⑧ Color: Blank-Natural GR-Gray

Poles	Dimensions(mm)			Poles	Dimensions(mm)		
	A	B	C		A	B	C
02	0.80	1.80	2.40	12	8.80	9.80	10.40
03	1.60	2.60	3.20	13	9.60	10.60	11.20
04	2.40	3.40	4.00	14	10.40	11.40	12.00
05	3.20	4.20	4.80	15	11.20	12.20	12.80
06	4.00	5.00	5.60	16	12.00	13.00	13.60
07	4.80	5.80	6.40	17	12.80	13.80	14.40
08	5.60	6.60	7.20	18	13.60	14.60	15.20
09	6.40	7.40	8.00	19	14.40	15.40	16.00
10	7.20	8.20	8.80	20	15.20	16.20	16.80
11	8.00	9.00	9.60	22	16.80	17.80	20.40



2023. 8. 9	B2	/	Update Drawing Frame	GUO	Larry Yang	GENERAL TOLERANCE .X ±0.30 .XX ±0.20 .XXX ±0.10 X.° ±2° PROJECT 	SMS 东莞市思索技术股份有限公司 Dongguan SESO Technology Co.,Ltd.				PART NO. 0800H-XXX-46XXXX				
2021. 2. 28	B1	/	ADD "HF" SPEC	古荣鑫	杨蒙						APPROVAL CHECK DRAWN DATE				TITLE 0.80mm Crimp Style Commtctors
2020.5.20	B	EN20200519001	Update Drawing Frame	YYting	Robing		Larry	Jane	sylvia	2015/06/30	UNIT	SCALE	SHEET	REV	NUMBER
DATE	REV	ECN NO.	DESCRIPTION	MODIFY	APPROVAL						mm	1:1	1/1	B2	A-106

RoHS

This products can apply to the SESO Doc NO. QA-3-04-005 of Environmental&Material Management Rules

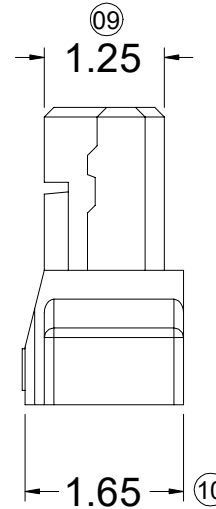
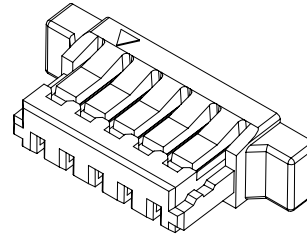
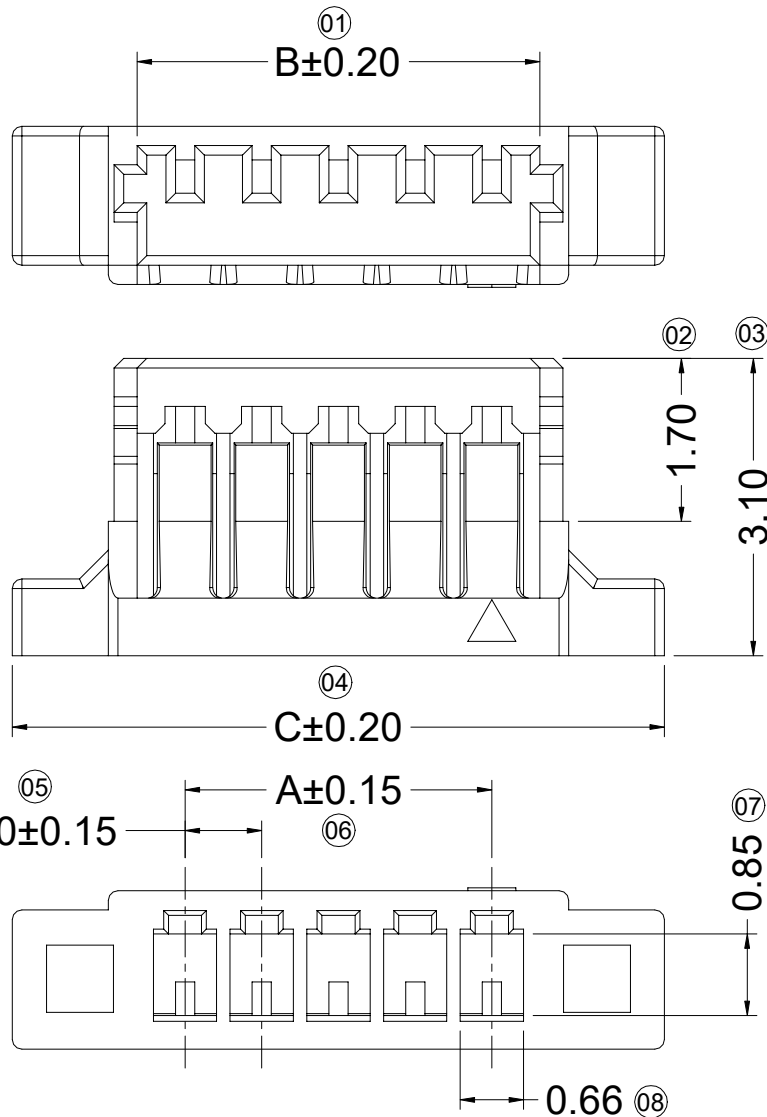

■ Specifications :

- Voltage rating: 30V AC / DC
- Current rating: 0.50A AC / DC
- Withstanding voltage: 200V AC/minute
- Temperature range: -40°C~+105°C
- Insulation resistance:≥100MΩ
- Contact resistance: ≤20mΩ
- After environmental testing: ≤40mΩ
- Suitable SESO Terminal: 0800T
- Mates With SESO Wafer: 0800W

0800 H X - XX E - 46 XX XX

① ② ③ ④ ⑤ ⑥ ⑦ ⑧

- ① Series No.
- ② Category: H-HSG
- ③ Connector type: Blank-ordinary
- ④ Row No.-Pin No per row: XX-Single row
- ⑤ Special No: E-With Ears
- ⑥ Material : 46-PA46 94V-0
- ⑦ RoHS: HF-Halogen-Free Blank-Rohs
- ⑧ Color: Blank-natural GR-Gray



Poles	Dimensions(mm)			Poles	Dimensions(mm)		
	A	B	C		A	B	C
02	0.80	1.80	4.40	12	8.80	9.80	12.40
03	1.60	2.60	5.20	13	9.60	10.60	13.20
04	2.40	3.40	6.00	14	10.40	11.40	14.00
05	3.20	4.20	6.80	15	11.20	12.20	14.80
06	4.00	5.00	7.60	16	12.00	13.00	15.60
07	4.80	5.80	8.40	17	12.80	13.80	16.40
08	5.60	6.60	9.20	18	13.60	14.60	17.20
09	6.40	7.40	10.00	19	14.40	15.40	18.00
10	7.20	8.20	10.80	20	15.20	16.20	18.80
11	8.00	9.00	11.60	22	16.80	17.80	20.40

2023. 8. 9	c1	/	Update Drawing Frame	GUO	Larry Yang	GENERAL TOLERANCE .X ±0.30 .XX ±0.20 .XXX ±0.10 X.° ±2°	SMS 东莞市思索技术股份有限公司 Dongguan SESO Technology Co.,Ltd.				PART NO. 0800H-XXE-46				
2021.04.16	c		Add Halogen Free P/N	Mali	Robing						APPROVAL CHECK DRAWN DATE				TITLE 0.80mm Crimp Style Commtctors
2020.5.20	B	EN20200519001	Update Drawing Frame	YYting	Robing		PROJECT				UNIT	SCALE	SHEET	REV	NUMBER
DATE	REV	ECN NO.	DESCRIPTION	MODIFY	APPROVAL		Robing YYting sylvia 2015/06/30				mm	1:1	1/1	C	A-022

RoHS

This products can apply to the SESO Doc NO. QA-3-04-005 of Environmental&Material Management Rules

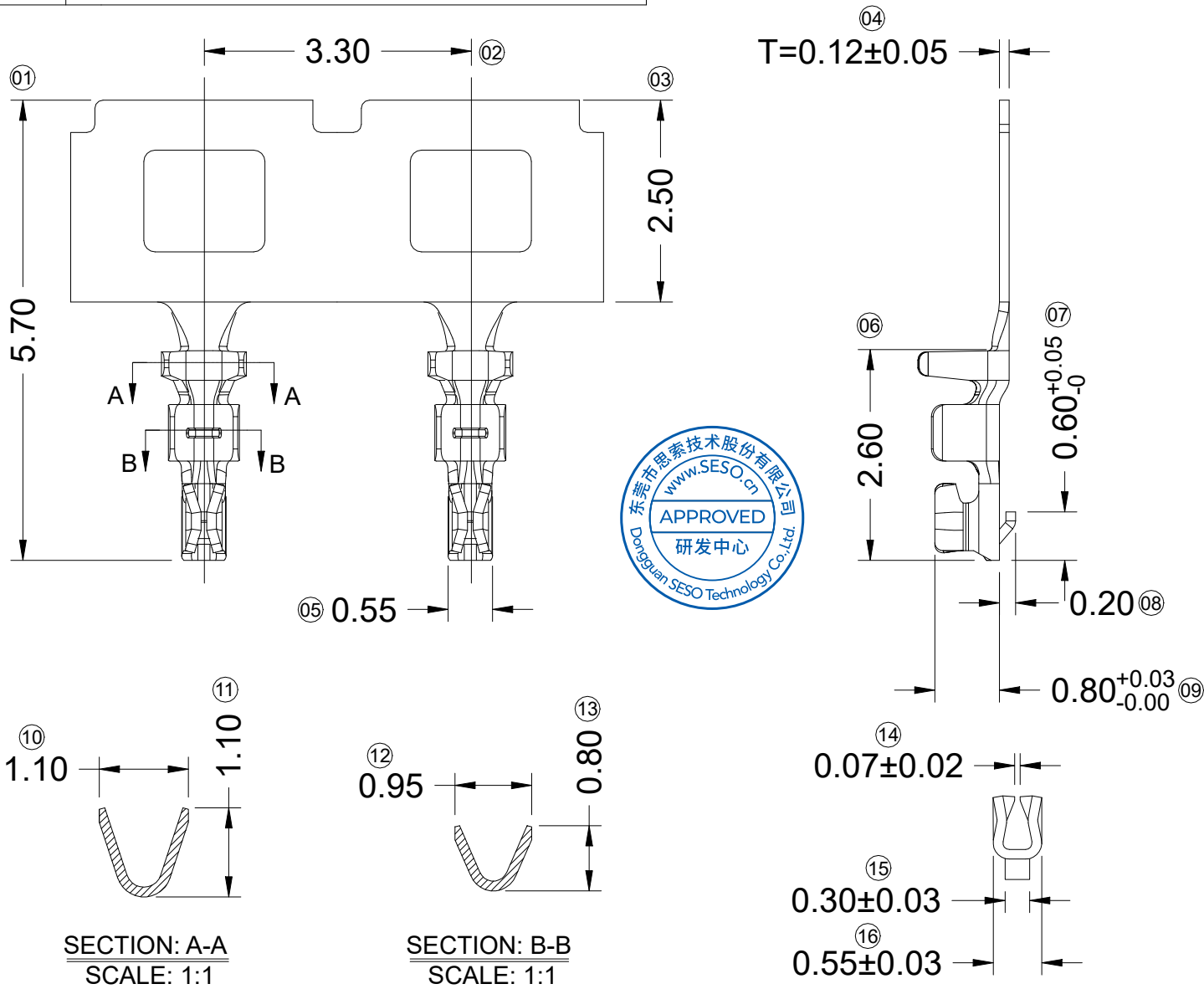

■ Specifications :

- Voltage rating: 30V AC / DC
- Current rating: 0.5A AC / DC
- Withstanding voltage: 200V AC/minute
- Temperature range: -40°C~+105°C
- Insulation resistance: ≥100MΩ
- Contact resistance: ≤20mΩ
- After environmental testing: ≤40mΩ
- Wire Range: AWG#32、AWG#30
- Insulation O.D: 0.60mm(Max)
- Used In SESO Housing: 0800H

0800 T X - P XXX X - X
① ② ③ ④ ⑤ ⑥ ⑦

- ① Series No
- ② Category: T-terminal
- ③ Shape: Blank-ordinary
- ④ Material: P-Phosphor bronze
- ⑤ Plating Code: SN-Bright tin plating
V01-Gold Flash
- ⑥ Plating method:
Blank-Stamping before plating
- ⑦ Mold No./Mark/Special No.

						GENERAL TOLERANCE				PART NO: 0800T-PXX				
						.X ±0.35				 东莞市思索技术股份有限公司 Dongguan SESO Technology Co.,Ltd.				
						.XX ±0.25								
						.XXX ±0.15								
						X.' ±2'								
						PROJECT				TITLE: 0.80mm Crimp Style Connectors				
						APPROVAL				APPROVAL				
						CHECK				CHECK				
						DRAWN				DRAWN				
						DATE				DATE				
						UNIT				UNIT				
						SCALE				SCALE				
						SHEET				SHEET				
						REV				REV				
						NUMBER				NUMBER				
						mm				mm				
						1:1				1:1				
						1/1				1/1				
						C1				C1				
						A-022				A-022				

RoHS

This products can apply to the SESO Doc NO. QA-3-04-005 of Environmental&Material Management Rules

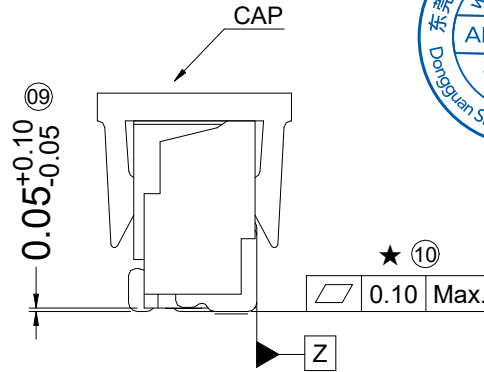
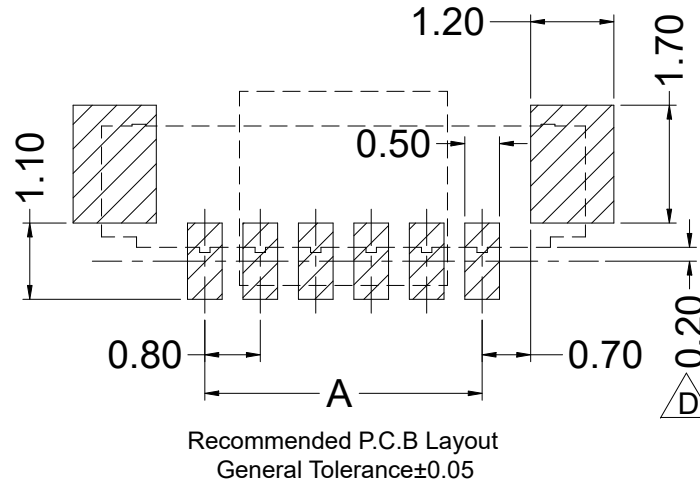
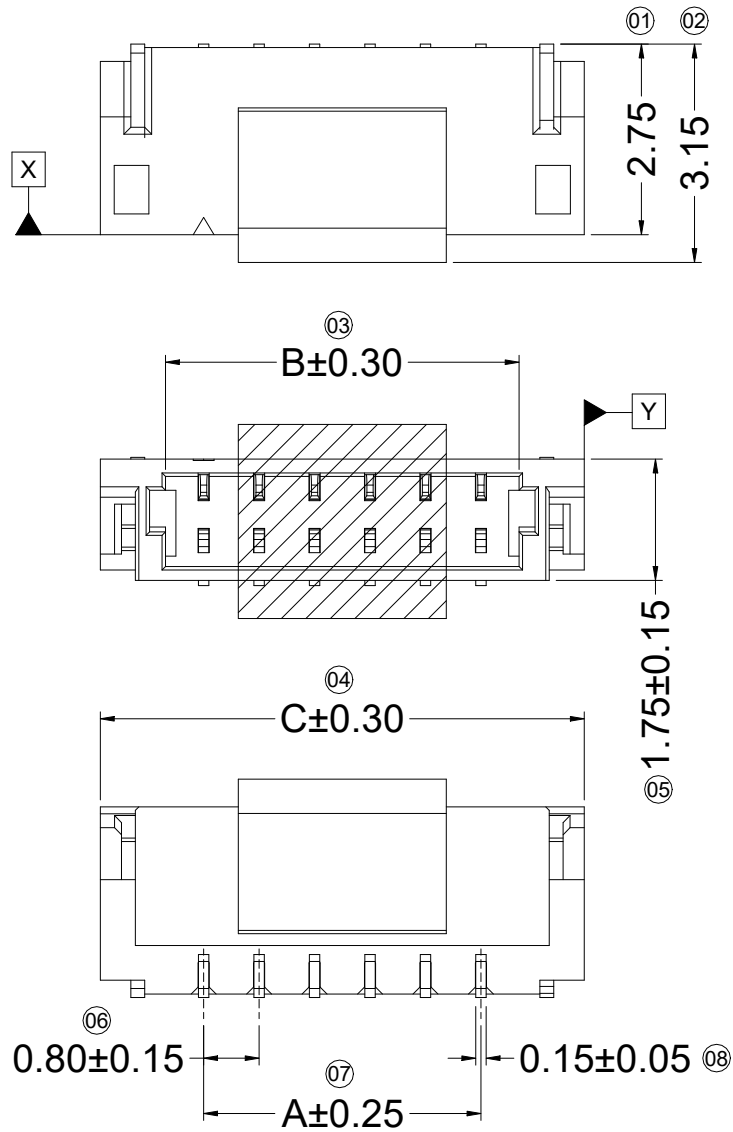

- Specifications :
- Voltage rating: 30V AC / DC
 - Current rating: 0.50A AC / DC
 - Withstanding voltage: 200V AC/minute
 - Temperature range: -40°C~+105°C
 - Insulation resistance: ≥100MΩ
 - Contact resistance: ≤20mΩ
 - After environmental testing: ≤40mΩ
 - Material(Pin): Phosphor Bronze
 - Material(Solder Tabs): Brass
 - Mates With SESO Housing: 0800H

0800 W V S - XX HF - LP XX X X X
 ① ②③④ ⑤ ⑥ ⑦ ⑧ ⑨⑩⑪

- ① Series No
- ② Category:W-WAFER
- ③ Connector Type:V-180°
- ④ Mouting Type: S-SMT
- ⑤ Row No.-Pin No.: XX-Single Row
- ⑥ Special No.:HF-Halogen Free
- ⑦ Material: LP -LCP 94V-0
- ⑧ Plating Code:
V01-All Gold Flash
SN-Bright Tin Plating
- ⑨ Color : Blank-Natural Color
- ⑩ Special No. : Blank-CAP(Natural); C-CAP(Black)
- ⑪ Package: Blank-Reel/Natural; R-Reel/ESD $\triangle D$

Poles	Dimensions (mm)			Poles	Dimensions (mm)		
	A	B	C		A	B	C
02	0.80	1.90	3.78	12	8.80	9.90	11.78
03	1.60	2.70	4.58	13	9.60	10.70	12.58
04	2.40	3.50	5.38	14	10.40	11.50	13.38
05	3.20	4.30	6.18	15	11.20	12.30	14.18
06	4.00	5.10	6.98	16	12.00	13.10	14.98
07	4.80	5.90	7.78	17	12.80	13.90	15.78
08	5.60	6.70	8.58	18	13.60	14.70	16.58
09	6.40	7.50	9.38	19	14.40	15.50	17.38
10	7.20	8.30	10.18	20	15.20	16.30	18.18
11	8.00	9.10	10.98				

DATE	REV	ECN NO.	DESCRIPTION	MODIFY	APPROVAL
2023.08.10	D1		Update Drawing Frame	GUO	LARRY YANG
2021.04.23	D		Add ESD Package P/N	HuangTao	Joshua
2020.08.14	C	EN20200814004	Add black cap	Susan Liu	Robing

GENERAL TOLERANCE		APPROVAL	CHECK	DRAWN	DATE
.X	±0.30				
.XX	±0.20				
.XXX	±0.10				
X.°	±2°				
PROJECT		Robing	YYting	Sylvia	2017/08/17

SMS 东莞市思索技术股份有限公司
 Dongguan SESO Technology Co.,Ltd.

PART NO.				
0800WVS-XXHF-LPXXXX				
TITLE				
0.80 mm IDC Style Connectors				
UNIT	SCALE	SHEET	REV	NUMBER
mm	1:1	1/1	D	A-016

RoHS

This products can apply to the SESO Doc NO. QA-3-04-005 of Environmental&Material Management Rules

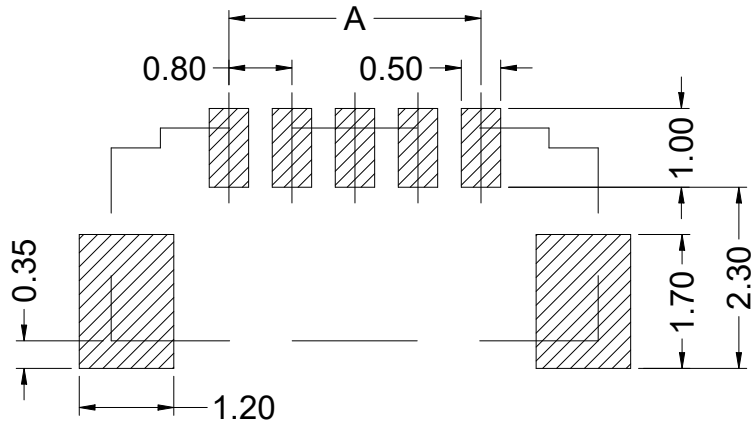
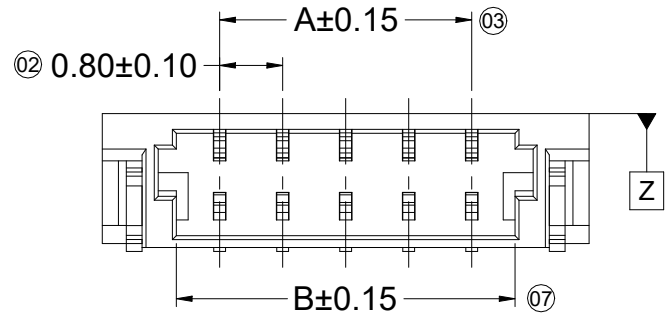
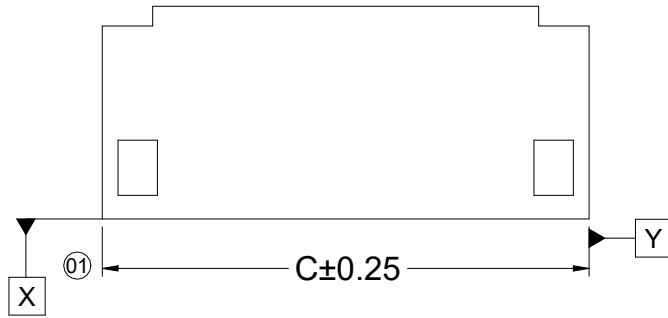
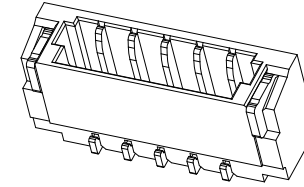

Recommended P.C.B Layout
General Tolerance±0.05

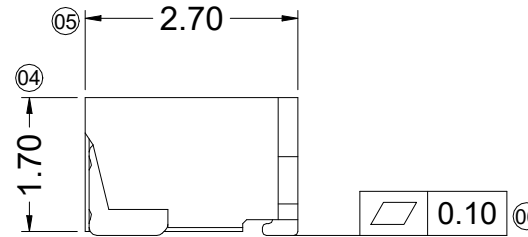

Poles	Dimensions(mm)			Poles	Dimensions(mm)		
	A	B	C		A	B	C
02	0.80	1.90	3.78	12	8.80	9.90	11.78
03	1.60	2.70	4.58	13	9.60	10.70	12.58
04	2.40	3.50	5.38	14	10.40	11.50	13.38
05	3.20	4.30	6.18	15	11.20	12.30	14.18
06	4.00	5.10	6.98	16	12.00	13.10	14.98
07	4.80	5.90	7.78	17	12.80	13.90	15.78
08	5.60	6.70	8.58	18	13.60	14.70	16.58
09	6.40	7.50	9.38	19	14.40	15.50	17.38
10	7.20	8.30	10.18	20	15.20	16.30	18.18
11	8.00	9.10	10.98				

Specifications :

- Voltage rating: 30V AC / DC
- Current rating: 0.50A AC / DC
- Withstanding voltage: 200V AC/minute
- Temperature range: -40°C~+105°C
- Insulation resistance:≥100MΩ
- Contact resistance: ≤20mΩ
- After environmental testing:≤30mΩ
- Material(Pin):Phosphor Bronze
- Material(Solder Tabs):Brass
- Mates With SESO Housing:0800H

0800 W R S - XX HF - XX XXX XX X
① ②③④ ⑤ ⑥ ⑦ ⑧ ⑨ ⑩

- ① Series No.
- ② Category:W-wafer
- ③ Connector Type:R-90°
- ④ Mouting Type:S-SMT
- ⑤ Row No.-Pin No.XX-Single row
- ⑥ Special No.: HF-Halogen free
- ⑦ Material:LP-LCP 94V-0 ; 4T-PA4T 94V-0
- ⑧ Plating Code: V01-All Gold-Flash
SN-Bright tin plating
- ⑨ Color:Blank-Natural color BK-Black
- ⑩ Package:Blank-Reel R-Reel/ESD

20230810	A2	/	Update Drawing Frame	Guo	Larry Yang
20211215	A1	EN20211215001	Add package P/N	Alan.qin	Mali
DATE	REV	ECN NO.	DESCRIPTION	MODIFY	APPROVAL

GENERAL TOLERANCE
.X ±0.30
.XX ±0.20
.XXX ±0.10
X.° ±2°

SMS 东莞市思索技术股份有限公司
Dongguan SESO Technology Co.,Ltd.

PROJECT: Yangmeng

PART NO. 0800WRS-XXHF-XXXXXXXX				
TITLE 0.80mm IDC Style Connectors				
UNIT	SCALE	SHEET	REV	NUMBER
MM	1:1	1/1	A2	A-159

APPROVAL	CHECK	DRAWN	DATE
Yangmeng	Alan.qin	Li.Song	2013/08/06