

RoHS

This products can apply to the SESO Doc NO. QA-3-04-005 of Environmental&Material Management Rules

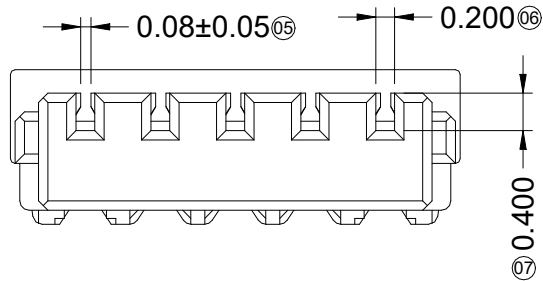
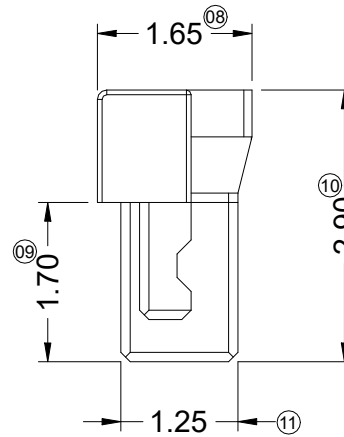
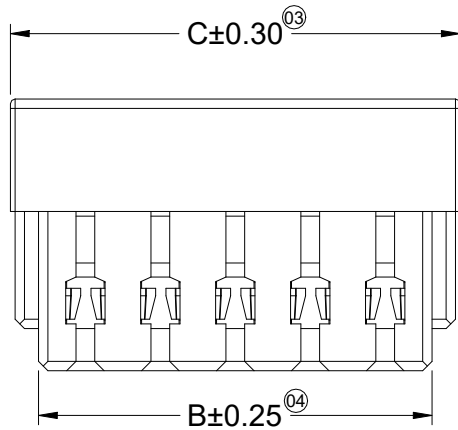
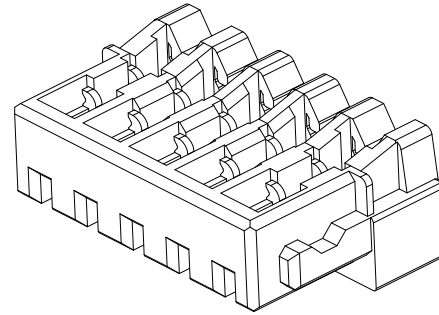
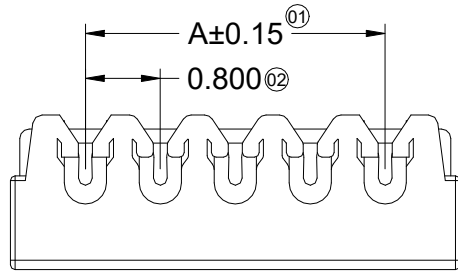

Specifications :

- Voltage rating: 30V AC / DC
- Current rating: 0.5A AC / DC
- Withstanding voltage: 200V AC/minute
- Temperature range: -25°C~+85°C
- Insulation resistance: ≥100MΩ
- Contact resistance: ≤20mΩ
- After environmental testing: ≤40mΩ
- Wire Range: AWG#32~36
- Insulation O.D.: 0.39mm(Max)
- Material(Terminal): Phosphor Bronze
- Mates With SESO Wafer: 0800W

0800 H I - XX X - N0 HF

① ②③ ④⑤ ⑥ ⑦

- ① Series No.
- ② Category: H-HSG
- ③ Connector type: I-HSG+hardware
- ④ Row No.-Pin No per row: XX-Single row
- ⑤ Special No: G-Gold Plating
- ⑥ Material : N0-PA66 94V-0
- ⑦ HF-Halogen free

Poles	Dimensions(mm)			Poles	Dimensions(mm)		
	A	B	C		A	B	C
02	0.80	1.78	2.40	12	8.80	9.78	10.40
03	1.60	2.58	3.20	13	9.60	10.58	11.20
04	2.40	3.38	4.00	14	10.40	11.38	12.00
05	3.20	4.18	4.80	15	11.20	12.18	12.80
06	4.00	4.98	5.60	16	12.00	12.98	13.60
07	4.80	5.78	6.40	17	12.80	13.78	14.40
08	5.60	6.58	7.20	18	13.60	14.58	15.20
09	6.40	7.38	8.00	19	14.40	15.38	16.00
10	7.20	8.18	8.80	20	15.20	16.18	16.80
11	8.00	8.98	9.60	22	16.00	17.78	18.40



2023/08/10	D	D1		更新图框	Guo	Larry Yang	GENERAL TOLERANCE .X ±0.30 .XX ±0.20 .XXX ±0.10	东莞市思索技术股份有限公司 Dongguan SESO Technology Co.,Ltd.	PART NO. 0800HI-XXG-N0HF						
2014/04/04	C	D		修改标示	Jova Lau	Bob Sun			TITLE 0.80mm IDC Style Connectors						
2013/11/11	B	C		修改图框格式	Jova Lau	Bob Sun			APPROVAL	CHECK	DRAWN	DATE			
DATE	OLD REV	NEW REV	ECN	DESCRIPTION	CHECK	APPROVAL	PROJECT	Kim Huang	Jova Lau	Allen	2007/05/03	UNIT MM	SCALE 1:1	NUMBER A-158	REV D1

RoHS

This products can apply to the SESO Doc NO. QA-3-04-005 of Environmental&Material Management Rules

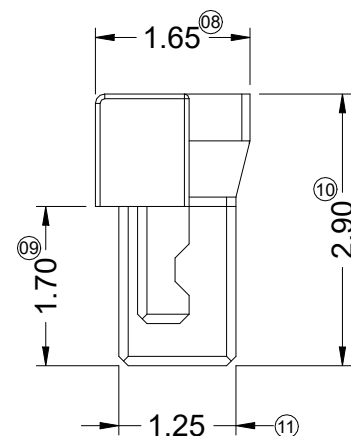
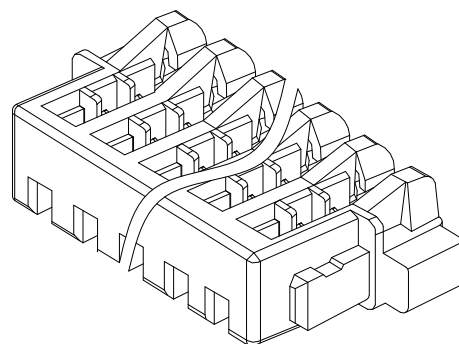
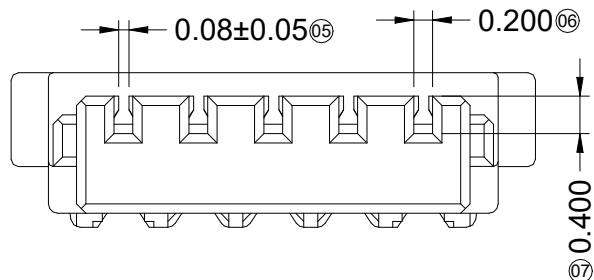
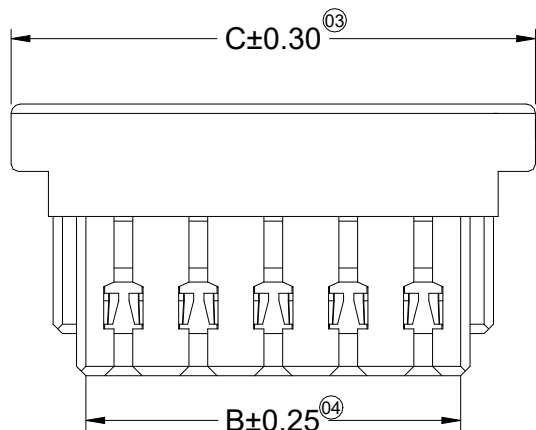
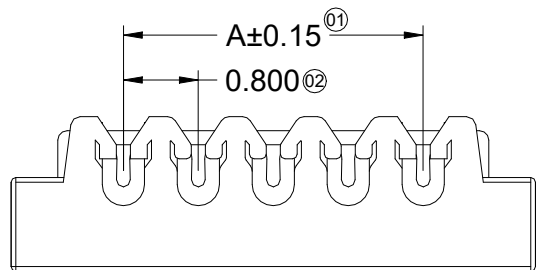

Specifications :

- Voltage rating: 30V AC / DC
- Current rating: 0.5A AC / DC
- Withstanding voltage: 200V AC/minute
- Temperature range: -25°C~+85°C
- Insulation resistance: ≥100MΩ
- Contact resistance: ≤20mΩ
- After environmental testing: ≤30mΩ
- Wire Range: AWG#32-34
- Insulation O.D.: 0.38mm(Max)
- Material(Terminal): Phosphor Bronze
- Mates With SESO Wafer: 0800W

0800 H I - XX E G - N0 HF

① ②③ ④ ⑤ ⑥ ⑦

- ① Series No.
- ② Category: H-HSG
- ③ Welding Board Angle: I-HSG+hardware
- ④ Row No.-Pin No.: XX-Single row
- ⑤ Special No.
E-Ear Clip ; G-Gold Plating
- ⑥ Material: N0-PA66 94V-0;
- ⑦ HF-Halogen free



Poles	Dimensions(mm)			Poles	Dimensions(mm)		
	A	B	C		A	B	C
02	0.80	1.78	3.20	12	8.80	9.78	11.20
03	1.60	2.58	4.00	13	9.60	10.58	12.00
04	2.40	3.38	4.80	14	10.40	11.38	12.80
05	3.20	4.18	5.60	15	11.20	12.18	13.60
06	4.00	4.98	6.40	16	12.00	12.98	14.40
07	4.80	5.78	7.20	17	12.80	13.78	15.20
08	5.60	6.58	8.00	18	13.60	14.58	16.00
09	6.40	7.38	8.80	19	14.40	15.38	16.80
10	7.20	8.18	9.60	20	15.20	16.18	17.60
11	8.00	8.98	10.40	22	16.80	17.78	19.20

2023/08/10	D	D1		更新图框	Guo	Larry Yang	GENERAL TOLERANCE .X ±0.30 .XX ±0.20 .XXX ±0.10	东莞市思索技术股份有限公司 Dongguan SESO Technology Co.,Ltd.	PART NO. 0800HI-XXEG-N0HF						
2014/04/04	C	D		修改标示	Jova Lau	Bob Sun			TITLE 0.80mm IDC Style Connectors						
2013/11/11	B	C		修改图框格式	Jova Lau	Bob Sun			APPROVAL	CHECK	DRAWN	DATA			
DATE	OLD REV	NEW REV	ECN	DESCRIPTION	CHECK	APPROVAL	PROJECT	Bob	Jova	Allen	2007/05/03	UNIT MM	SCALE 1:1	NUMBER A-158	REV D1

RoHS

This products can apply to the SESO Doc NO. QA-3-04-005 of Environmental&Material Management Rules

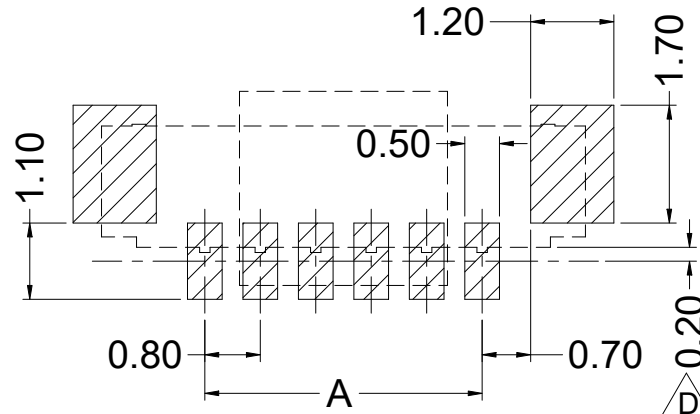
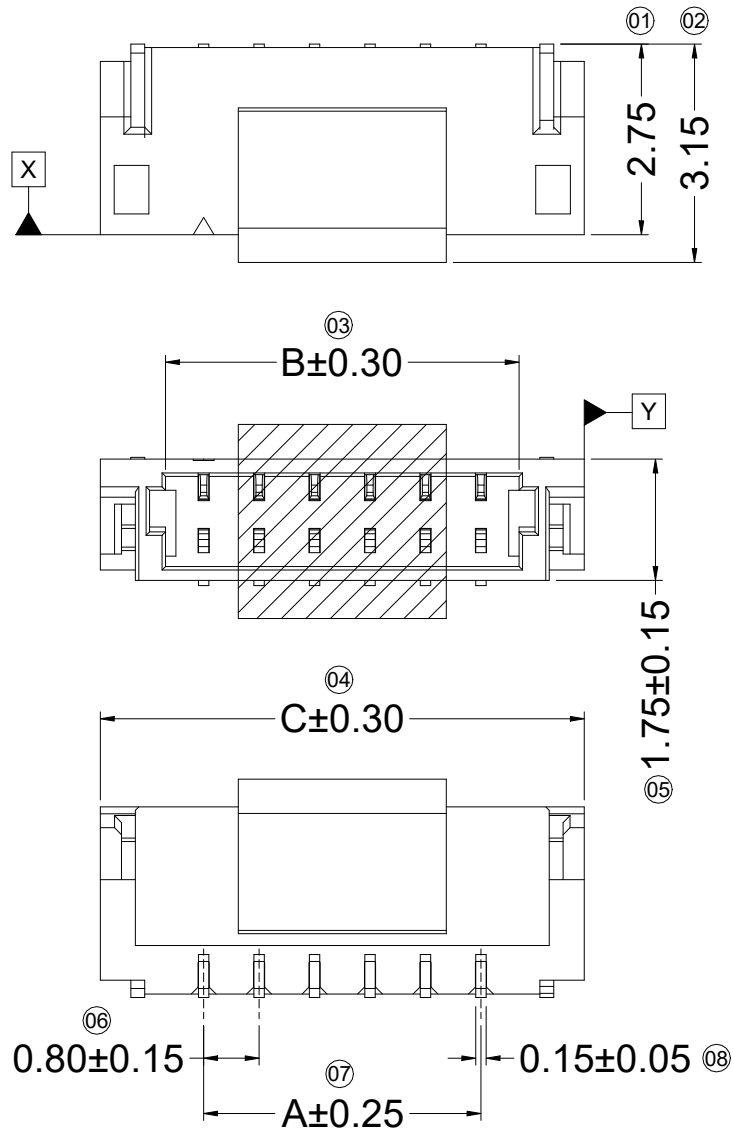

Recommended P.C.B Layout
General Tolerance±0.05



- Specifications :
- Voltage rating: 30V AC / DC
 - Current rating: 0.50A AC / DC
 - Withstanding voltage: 200V AC/minute
 - Temperature range: -40°C~+105°C
 - Insulation resistance: ≥100MΩ
 - Contact resistance: ≤20mΩ
 - After environmental testing: ≤40mΩ
 - Material(Pin): Phosphor Bronze
 - Material(Solder Tabs): Brass
 - Mates With SESO Housing: 0800H

0800 W V S - XX HF - LP XX X X X

① ②③④ ⑤ ⑥ ⑦ ⑧ ⑨⑩⑪

- ① Series No
- ② Category:W-WAFER
- ③ Connector Type:V-180°
- ④ Mouting Type: S-SMT
- ⑤ Row No.-Pin No.: XX-Single Row
- ⑥ Special No.:HF-Halogen Free
- ⑦ Material: LP -LCP 94V-0
- ⑧ Plating Code:
V01-All Gold Flash
SN-Bright Tin Plating
- ⑨ Color : Blank-Natural Color
- ⑩ Special No. : Blank-CAP(Natural); C-CAP(Black)
- ⑪ Package: Blank-Reel/Natural; R-Reel/ESD $\triangle D$

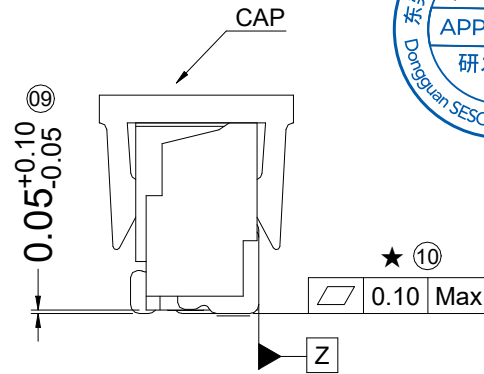

Poles	Dimensions (mm)			Poles	Dimensions (mm)		
	A	B	C		A	B	C
02	0.80	1.90	3.78	12	8.80	9.90	11.78
03	1.60	2.70	4.58	13	9.60	10.70	12.58
04	2.40	3.50	5.38	14	10.40	11.50	13.38
05	3.20	4.30	6.18	15	11.20	12.30	14.18
06	4.00	5.10	6.98	16	12.00	13.10	14.98
07	4.80	5.90	7.78	17	12.80	13.90	15.78
08	5.60	6.70	8.58	18	13.60	14.70	16.58
09	6.40	7.50	9.38	19	14.40	15.50	17.38
10	7.20	8.30	10.18	20	15.20	16.30	18.18
11	8.00	9.10	10.98				

DATE	REV	ECN NO.	DESCRIPTION	MODIFY	APPROVAL
2023.08.10	D1		Update Drawing Frame	Guo	Larry Yang
2021.04.23	D		Add ESD Package P/N	HuangTao	Joshua
2020.08.14	C	EN20200814004	Add black cap	Susan Liu	Robing

GENERAL TOLERANCE		PROJECT	APPROVAL	CHECK	DRAWN	DATE				
.X	±0.30						Robing	YYting	Sylvia	2017/08/17
.XX	±0.20									
.XXX	±0.10									
X.°	±2°									

SMS 东莞市思索技术股份有限公司
Dongguan SESO Technology Co.,Ltd.

PART NO.				
0800WVS-XXHF-LPXXXXX				
TITLE				
0.80 mm IDC Style Connectors				
UNIT	SCALE	SHEET	REV	NUMBER
mm	1:1	1/1	D	A-016

RoHS

This products can apply to the SESO Doc NO. QA-3-04-005 of Environmental&Material Management Rules

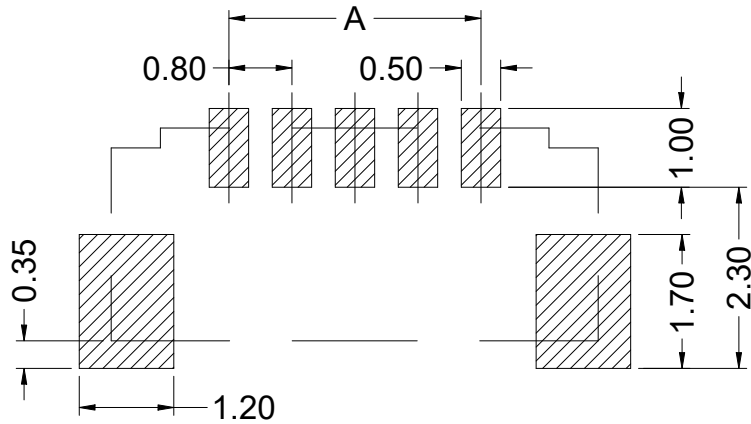
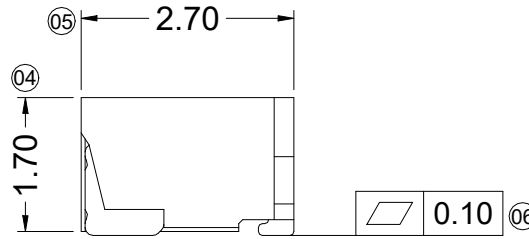
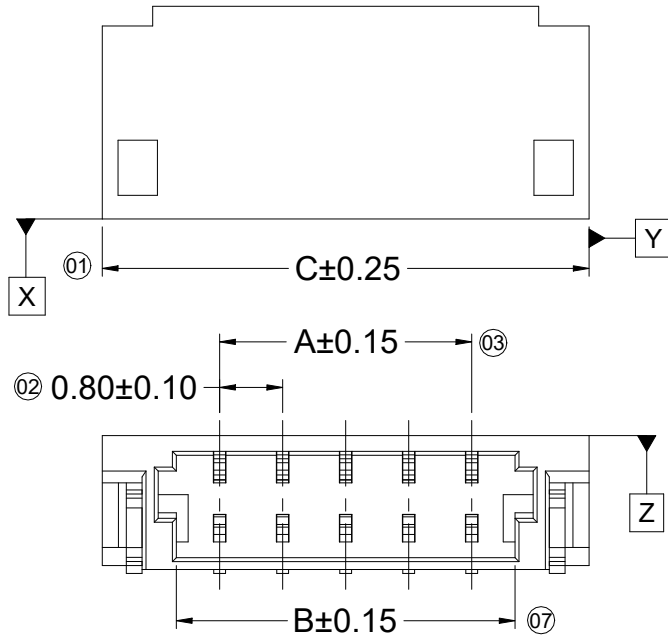
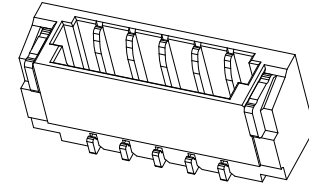

Recommended P.C.B Layout
General Tolerance±0.05

- Specifications :
- Voltage rating: 30V AC / DC
 - Current rating: 0.50A AC / DC
 - Withstanding voltage: 200V AC/minute
 - Temperature range: -40°C~+105°C
 - Insulation resistance:≥100MΩ
 - Contact resistance: ≤20mΩ
 - After environmental testing:≤30mΩ
 - Material(Pin):Phosphor Bronze
 - Material(Solder Tabs):Brass
 - Mates With SESO Housing:0800H

0800 W R S - XX HF - XX XXX XX X
① ②③④ ⑤ ⑥ ⑦ ⑧ ⑨ ⑩

- ① Series No.
- ② Category:W-wafer
- ③ Connector Type:R-90°
- ④ Mouting Type:S-SMT
- ⑤ Row No.-Pin No.XX-Single row
- ⑥ Special No.: HF-Halogen free
- ⑦ Material:LP-LCP 94V-0 ; 4T-PA4T 94V-0
- ⑧ Plating Code: V01-All Gold-Flash
SN-Bright tin plating
- ⑨ Color:Blank-Natural color BK-Black
- ⑩ Package:Blank-Reel R-Reel/ESD

Poles	Dimensions(mm)			Poles	Dimensions(mm)		
	A	B	C		A	B	C
02	0.80	1.90	3.78	12	8.80	9.90	11.78
03	1.60	2.70	4.58	13	9.60	10.70	12.58
04	2.40	3.50	5.38	14	10.40	11.50	13.38
05	3.20	4.30	6.18	15	11.20	12.30	14.18
06	4.00	5.10	6.98	16	12.00	13.10	14.98
07	4.80	5.90	7.78	17	12.80	13.90	15.78
08	5.60	6.70	8.58	18	13.60	14.70	16.58
09	6.40	7.50	9.38	19	14.40	15.50	17.38
10	7.20	8.30	10.18	20	15.20	16.30	18.18
11	8.00	9.10	10.98				

GENERAL TOLERANCE						东莞市思索技术股份有限公司 Dongguan SESO Technology Co.,Ltd.				PART NO.					
PROJECT										APPROVAL				TITLE	
20230810	A2	/	Update Drawing Frame	Guo	Larry Yang	.X ±0.30	Yangmeng	Alan.qin	Li.Song	2013/08/06	0800WRS-XXHF-XXXXXXXXX				
20211215	A1	EN20211215001	Add package P/N	Alan.qin	Mali	.XX ±0.20					0.80mm IDC Style Connectors				
DATE	REV	ECN NO.	DESCRIPTION	MODIFY	APPROVAL	.XXX ±0.10					UNIT	SCALE	SHEET	REV	NUMBER
						X° ±2°					MM	1:1	1/1	A2	A-159